

VALVES

QUICK - REFERENCE GUIDE

ITEM	DETAILS	PAGE
ORIFICE TUBES - CCOT and FOTCC	365
POAST and STV VALVES (SUCTION THROTTLING VALVES)	365
SOLENOID VALVES (FLOW CONTROL VALVES)	365
TX VALVES		
- APPLICATION GUIDE (list by vehicle make / model)	369 - 378
- BASIC TYPES, IDENTIFICATION OF VALVES & FITTINGS	366
- SPECIFICATION CHART	367 - 368
- ILLUSTRATED LISTING BY PART NUMBER	379 - 385
VIR VALVES (VALVES - IN - RECEIVER)	386
SPARES		
- MISCELLANEOUS PARTS	386
- O-RINGS	386

CCOT & FOTCC Valves (orifice tubes)

CCOT / FOTCC VALVE ASSEMBLIES

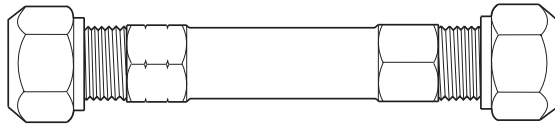

VA-10350

ORIFICE TUBE ASSEMBLY - GM CCOT
 Fittings: No.8 MIOR with compression fitting,
 (nut and olive included)
 NOTE: order applicable orifice

REPLACEMENT ORIFICE TUBES

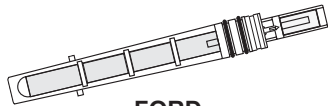

FORD
 REPLACEMENT FORD FOTCC
 ORIFICE TUBE

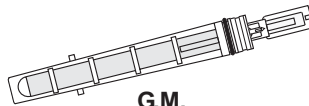

G.M.
 REPLACEMENT LATE GM CCOT
 ORIFICE TUBE

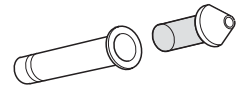

DANFOSS
 REPLACEMENT ORIFICE TUBE
 FOR VARIABLE ORIFICE TX VALVE

Orifice Tube Identification Chart

PART No.	ORIFICE TUBE/ASSEMBLY	TYPE	APPLICATION	SIZE	IDENTIFICATION
VA-10130	REPLACEMENT ORIFICE TUBE	DANFOSS	- VA-13405, VA-13445	1.0 Ton	# 3
VA-10140	REPLACEMENT ORIFICE TUBE	DANFOSS	- VA-13405, VA-13445	1.5 Ton	# 4
VA-10150	REPLACEMENT ORIFICE TUBE	DANFOSS	- VA-13405, VA-13445	2.0 Ton	# 5
VA-10160	REPLACEMENT ORIFICE TUBE	DANFOSS	- VA-13405, VA-13445	3.0 Ton	# 6
VA-10220	REPLACEMENT ORIFICE TUBE	FORD FOTCC	- FORD FALCON AU	0.057"	ORANGE
VA-10244	REPLACEMENT ORIFICE TUBE	GM / FORD	- FORD FALCON BA	0.062"	RED
VA-10250	REPLACEMENT ORIFICE TUBE	GM CCOT	- COMMODORE VN - VP	0.067"	BLUE
VA-10270	REPLACEMENT ORIFICE TUBE	GM CCOT	- COMMODORE VB - VC	0.071"	WHITE
			- DAEWOO CIELO to 7/97	0.071"	WHITE

Poast / STV Valves

POAST AND STV VALVES



VA-10565

COMPLETE VALVE ASSEMBLY
 (DISCONTINUED)

Solenoid (Flow Control) Valves

SOLENOID VALVES

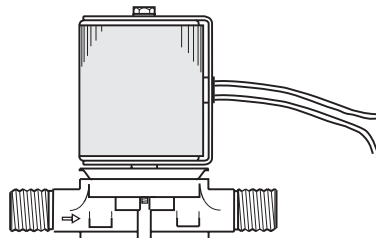

VA-12580

12 VOLT
 #6 MIOR - #6 MIOR

VA-12624

24 VOLT
 #6 MIOR - #6 MIOR

Thermostatic Expansion Valves

TX IDENTIFICATION; PARTS & FITTINGS

Standard Right Angle TX Valves

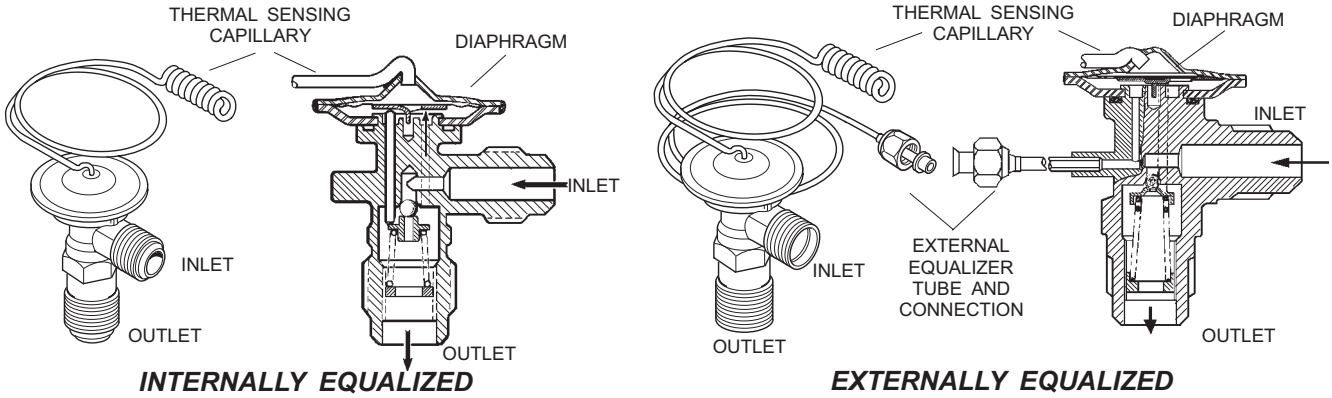

Block TX Valves

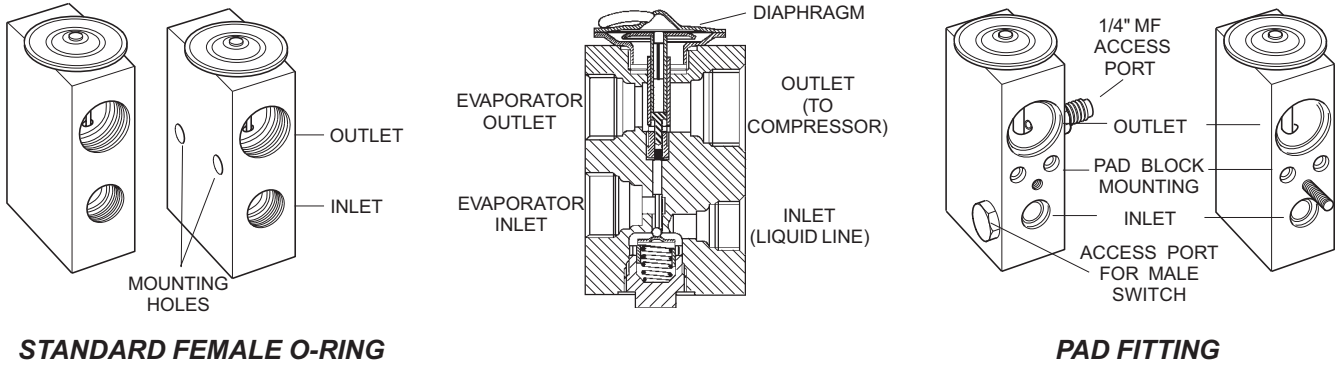

Hose Fittings: Basic Types

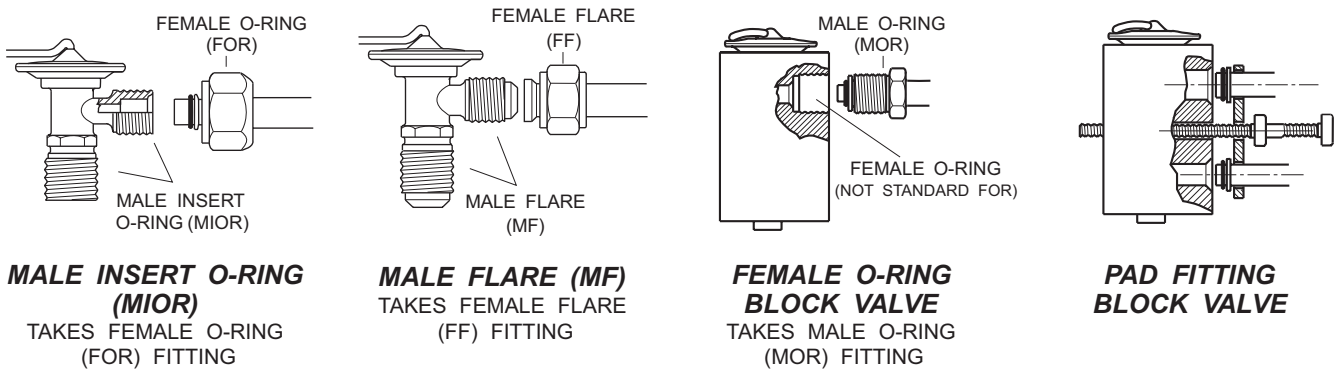

External Equalizer Connections

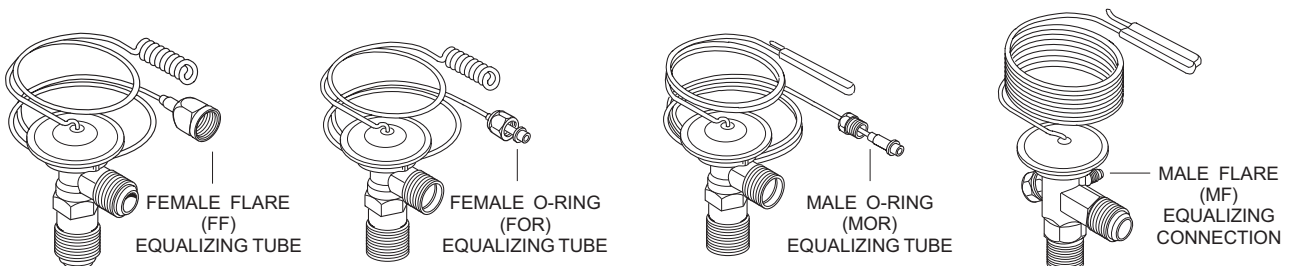

Thermostatic Expansion Valves

TX VALVE SPECIFICATION CHART

PART No.	ASSEMBLY STD / REV	FITTINGS INLET - OUTLET	CAPILLARY LENGTH - TYPE	EQUALIZER TYPE - CAPILLARY - FTGS	SUPERHEAT Degrees C.	RATING (Tons)
Internally Equalized Flare: No.6 - No.8						
VA-13405	STANDARD	# 6 MF - # 8 MF	1500 mm - BULB	INTERNAL	N - A	Variable
VA-13410	STANDARD	# 6 MF - # 8 MF	200 mm - COIL	INTERNAL	N - A	1.0
VA-13415	STANDARD	# 6 MF - # 8 MF	305 mm - COIL	INTERNAL	N - A	1.5
VA-13420	STANDARD	# 6 MF - # 8 MF	305 mm - COIL	INTERNAL	N - A	2.0
Externally Equalized Flare: No.6 - No.8						
VA-13434	STANDARD	# 6 MF - # 8 MF	483 mm - COIL	EXTERNAL	419 mm FF	1.5
VA-13438	STANDARD	# 6 MF - # 8 MF	465 mm - COIL	EXTERNAL	700 mm FF	2.0
VA-13445	STANDARD	# 6 MF - # 8 MF	1500 mm - BULB	EXTERNAL	N - A 1/4" M-F	Variable
Internally Equalized MIOR: No.5 - No.8						
VA-25447	COMPACT	# 5 MIOR - # 8 MIOR	265 mm - COIL	INTERNAL	N - A	1.0
VA-25510	COMPACT	# 5 MIOR - # 8 MIOR	200 mm - COIL	INTERNAL	N - A	1.5
VA-25525	REVERSE	# 5 MIOR - # 8 MIOR	360 mm - BULB	INTERNAL	N - A	1.5
Internally Equalized MIOR: No.6 - No.8						
VA-27140	STANDARD	# 6 MIOR - # 8 MIOR	230 mm - COIL	INTERNAL	N - A	1.0
VA-27462	STANDARD	# 6 MIOR - # 8 MIOR	203 mm - COIL	INTERNAL	N - A	1.5
VA-27494	COMPACT	# 6 MIOR - # 8 MIOR	200 mm - COIL	INTERNAL	N - A	1.0
VA-27668	REVERSE	# 6 MIOR - # 8 MIOR	305 mm - BULB	INTERNAL	N - A	2.0
VA-27687	STANDARD	# 6 MIOR - # 8 MIOR	305 mm - COIL	INTERNAL	N - A	2.0
Internally Equalized : Metric Fittings						
VA-30940	STANDARD	M16 MIOR- M20 MIOR	210 mm - COIL	INTERNAL	N - A	1.0
VA-30952	REVERSE	M16 COR - M22 COR	190 mm - BULB	INTERNAL	N - A	1.0
VA-31074	REVERSE	M16 MIOR- M20 MIOR	280 mm - BULB	INTERNAL	N - A	1.5
VA-31214	STANDARD	M16 COR - M22 COR	290 mm - COIL	INTERNAL	N - A	1.5
Externally Equalized MIOR: No.5 - No.8						
VA-33105	STANDARD	# 5 MIOR - # 8 MIOR	230 mm - BULB	EXTERNAL	200 mm FOR	1.0
VA-33122	REVERSE	# 5 MIOR - # 8 MIOR	230 mm - BULB	EXTERNAL	550 mm FOR	1.0
VA-33138	STANDARD	# 5 MIOR - # 8 MIOR	230 mm - BULB	EXTERNAL	650 mm FOR	1.0
VA-33169	REVERSE	# 5 MIOR - # 8 MIOR	230 mm - BULB	EXTERNAL	620 mm PAD	
VA-33174	REVERSE	# 5 MIOR - # 8 MIOR	220 mm - BULB	EXTERNAL	310 mm FF	
VA-33178	REVERSE	# 5 MIOR - # 8 MIOR	305 mm - BULB	EXTERNAL	838 mm FOR	1.5
VA-33196	REVERSE	# 5 MIOR* - # 8 MIOR	195 mm - BULB	EXTERNAL	215 mm 1/4" FOR	1.5
(* VA-33196 has large internal diameter on inlet)						
Externally Equalized MIOR: No.6 - No.8						
VA-34123	STANDARD	# 6 MIOR - # 8 MIOR	203 mm - COIL	EXTERNAL	247 mm FOR	1.0
VA-34464	STANDARD	# 6 MIOR - # 8 MIOR	305 mm - COIL	EXTERNAL	330 mm FOR	1.5
VA-34489	STANDARD	# 6 MIOR - # 8 MIOR	483 mm - COIL	EXTERNAL	420 mm FOR	1.5
VA-34637	STANDARD	# 6 MIOR - # 8 MIOR	203 mm - BULB	EXTERNAL	248 mm FOR	2.0
VA-34662	STANDARD	# 6 MIOR - # 8 MIOR	203 mm - COIL	EXTERNAL	248 mm FOR	2.0
VA-34691	STANDARD	# 6 MIOR - # 8 MIOR	305 mm - COIL	EXTERNAL	419 mm FOR	2.0
VA-34867	STANDARD	# 6 MIOR - # 8 MIOR	838 mm - BULB	EXTERNAL	787 mm MOR	2.0
Externally Equalized : Metric Fittings						
VA-35462	REVERSE	M16 MIOR- # 8 MIOR	305 mm - BULB	EXTERNAL	838 mm FOR	1.5
VA-36324	STANDARD	M16 MIOR- M20 MIOR	235 mm - BULB	EXTERNAL	310 mm M12 FOR	1.0
VA-36356	REVERSE	M16 MIOR- M20 MIOR	190 mm - BULB	EXTERNAL	305 mm FOR	1.0
VA-36461	REVERSE	M16 MIOR- M20 MIOR	215 mm - BULB	EXTERNAL	215 mm FOR	1.5
VA-36468	REVERSE	M16 MIOR- M20 MIOR	285 mm - BULB	EXTERNAL	230 mm M12 FOR	1.0
VA-36472	REVERSE	M16 MIOR- M20 MIOR	305 mm - BULB	EXTERNAL	324 mm M12 FOR	1.5
VA-37477	STANDARD	M14 MIOR- M20 MIOR	280 mm - BULB	EXTERNAL	240 mm M12 FOR	1.0
VA-37511	REVERSE	M16 COR - M22 COR	380 mm - BULB	EXTERNAL	340 mm M12 FOR	1.0
VA-37653	REVERSE	M16 COR - M22 COR	220 mm - BULB	EXTERNAL	715 mm PAD	1.5

Thermostatic Expansion Valves

TX VALVE SPECIFICATION CHART

PART No.	ASSEMBLY	FITTINGS		EVAPORATOR FITTINGS		SUPERHEAT Degrees C.	RATING (Tons)
		INLET	OUTLET	INLET	OUTLET		
Block Valves : FOR, No.6 - No.8							
VA-46282	BLOCK	# 6 FOR	- # 8 FOR	# 8 FOR	- #10 FOR	2.80 °C	1.5
Block Valves : FOR, No.6 - No.10							
VA-46528	BLOCK	# 6 FOR	- #10 FOR	# 8 FOR	- # 8 FOR	2.78 °C	1.5
VA-46542	BLOCK	# 6 FOR	- #10 FOR	# 8 FOR	- #10 FOR	4.44 °C	1.5
VA-46560	BLOCK	# 6 FOR	- #10 FOR	# 8 FOR	- # 8 FOR	4.44 °C	1.5
VA-46875	BLOCK	# 6 FOR	- #10 FOR	# 8 FOR	- # 8 FOR	3.50 °C	2.0
VA-46913	BLOCK	# 6 FOR	- #10 FOR	# 8 FOR	- # 8 FOR		
VA-46924	BLOCK	# 6 FOR	- #10 FOR	# 8 FOR	- #10 FOR	2.78 °C	2.0
VA-46960	BLOCK	# 6 FOR	- #10 FOR	# 8 FOR	- # 8 FOR	2.78 °C	2.0
VA-46983	BLOCK	# 6 FOR	- #10 FOR	# 8 FOR	- #10 FOR	2.78 °C	2.0
Block Valves : Pad, No.5 - No.10							
VA-48865	BLOCK	# 5 PAD	- #10 PAD	#10 PAD	- #10 PAD	4.00 °C	2.0
VA-48902	BLOCK	# 5 PAD	- #10 PAD	#10 PAD	- #10 PAD		
VA-48952	BLOCK	# 5 PAD	- #10 PAD	# 8 PAD	- #10 PAD		
VA-48977	BLOCK	# 5 PAD	- #10 PAD	# 8 PAD	- #10 PAD		
VA-49824	BLOCK	# 5 PAD	- #10 PAD	19.5mm PAD	- #10 PAD	4.44 °C	2.0
Block Valves : Pad, No.6							
VA-51733	BLOCK	# 6 PAD	- #12 PAD	# 8 PAD	- #10 PAD		
VA-51781	BLOCK	# 6 PAD	- #12 PAD	# 8 PAD	- #10 PAD		
VA-52714	BLOCK	M11 PAD	- M20 PAD	M14 PAD	- M20 PAD	3.60 °C	1.5
VA-52838	BLOCK	# 6 PAD	- #12 PAD	# 8 PAD	- #10 PAD	29.5 lbs/in ²	1.5
VA-52915	BLOCK	# 6 PAD	- #10 PAD	# 8 PAD	- # 8 PAD	4.44 °C	1.5
VA-52919	BLOCK	# 6 PAD	- #10 PAD				
VA-52947	BLOCK	# 6 PAD	- #12 PAD	# 8 PAD	- #10 PAD		
VA-52956	BLOCK	# 6 PAD	- #10 PAD				
VA-54592	BLOCK	# 6 PAD	- #10 PAD	# 8 PAD	- #10 PAD	2.78 °C	2.5
VA-54598	BLOCK	# 6 PAD	- #10 PAD	# 8 PAD	- #10 PAD	2.78 °C	2.5
VA-54610	BLOCK	# 6 PAD	- #10 PAD	# 8 PAD	- #10 PAD	2.78 °C	2.5
VA-57693	BLOCK	# 6 PAD	- #12 PAD	# 8 PAD	- #10 PAD		1.8
VA-57780	BLOCK	# 6 PAD	- #12 PAD	# 8 PAD	- #10 PAD	4.44 °C	1.7
VA-57830	BLOCK	# 6 PAD	- #12 PAD	# 8 PAD	- #10 PAD	3.00 °C	2.0
VA-57912	BLOCK	# 6 PAD	- #12 PAD	# 8 PAD	- #10 PAD	6.00 °C	2.0
VA-57984	BLOCK	# 6 PAD	- #12 PAD	# 8 PAD	- #10 PAD	3.50 °C	2.0
Block Valves : Pad, No.8							
VA-59965	BLOCK	# 8 PAD	- #12 PAD	# 8 PAD	- #12 PAD	3.60 °C	1.8



Technical Tip

Always fit the **CORRECT** TX Valve or Orifice.
Both the rating (capacity) **and** the superheat setting **must** be correct.

Capacity:

TX Valves are rated in tons.

The tonnage of a valve simply refers to its capacity. (1 ton = 12,000 BTU/HR).

A valve which has a rating which is too small for the coil will 'starve' the coil and system performance will be reduced .

A valve which is too big for the coil may cause 'flooding' and in extreme cases can cause liquid slugging which can damage the compressor.

Superheat :

If a valve with a superheat setting which is too low for the coil is used, the valve will open too early and flooding may occur.

A valve with a superheat setting too high will not open as early as it should and the coil may be starved, reducing performance.

TX Valve Application Guide

Application Guide by Vehicle Make / Model

Vehicle	Model / Code	Year	Type	Fittings	Part No.	S/Sedes	Page	Other / OEM Reference
ALFA - ROMEO								
ALFA	33		BLOCK	PAD - PAD	VA-57780	VA-13780	385	
ALFA	145 BOXER ENGINE		Orifice Tube		VA-10244		365	
ALFA	145 TD		Orifice Tube		VA-10244		365	
ALFA	155	03/92 - 10/93	Orifice Tube		VA-10244		365	
ALFA	164	05/88 - ON	STD. - EXT.	MIOR - MIOR	VA-34662	VA-13484	382	
ALFETTA	MOST		STD. - INT.	MIOR - MIOR	VA-27462	VA-13450	380	
ALFA	COUPE		Orifice Tube		VA-10244		365	
ALFA	SPIDER 2litre 16V		Orifice Tube		VA-10244		365	
ALLIS CHALMERS								
TRACTORS	7040, 7060, 7080, 7580		STD. - EXT.	MIOR - MIOR	VA-34637	VA-13480	382	OE: 70268470-5
TRACTORS	8550		STD. - EXT.	MIOR - MIOR	VA-34637	VA-13480	382	OE: 70268470-5
TRACTORS	L, L2, M, F2, N5, N6, N7		BLOCK	FOR - FOR	VA-46528	VA-13528	383	OE: 71307202-3
SOME			BLOCK	FOR - FOR	VA-46560	VA-13730	383	
A M C								
SOME	WITH STANDARD VALVE		STD. - INT.	MF - MF	VA-13415		379	
SOME	WITH STANDARD VALVE		STD. - INT.	MIOR - MIOR	VA-27462	VA-13450	380	
SOME	WITH STANDARD VALVE		STD. - INT.	MIOR - MIOR	VA-27687	VA-13455	380	
SOME	WITH BLOCK VALVE		BLOCK	FOR - FOR	VA-46560	VA-13730	383	
SOME	WITH BLOCK VALVE		BLOCK	FOR - FOR	VA-46875	VA-13575	383	
A R A								
ROOFTOPS	WITH FLARE VALVE		STD. - INT.	MF - MF	VA-13415		379	OE: 1296301; 1296339
ROOFTOPS	WITH O-RING VALVE		STD. - INT.	MIOR - MIOR	VA-27462	VA-13450	380	OE: 1296340
ROOFTOPS	WITH BLOCK VALVE		BLOCK	FOR - FOR	VA-46875	VA-13575	383	
AUDI								
AUDI	80	10/92 - ON	Orifice Tube		VA-10244		365	
AUDI	100LS, 100CD	EARLY-	STD. - EXT.	MF - MF	VA-13434		379	
AUDI	100	08/82 - ON	Orifice Tube		VA-10244		365	
AUDI	4000		STD. - INT.	MF - MF	VA-13415		379	OE: 1296301; 1296339
AUDI	A3	1996 - ON	BLOCK	PAD - PAD	VA-52947	VA-13960	384	
AUDI	A4	11/94 - ON	Orifice Tube		VA-10244		365	
AUDI	A6	06/94 - ON	Orifice Tube		VA-10244		365	
AUDI	A8	06/94 - ON	Orifice Tube		VA-10244		365	
AUDI	FOX 100LS		STD. - EXT.	MF - MF	VA-13434		379	OE: ZAW-411-057
BERGSTROM								
SOME			BLOCK	FOR - FOR	VA-46560	VA-13730	383	OE: 58294; 540031
SOME			BLOCK	FOR - FOR	VA-46983	VA-13770	384	OE: 54020; 540021
SOME			STD. - EXT.	MIOR - MIOR	VA-34691	VA-13488	382	OE: 57627
B M W								
3-SERIES	ALL MODELS	TO - 1983	STD. - EXT.	MF - MF	VA-13434		379	OE: 64-511-354-379
3-SERIES	E30	1985 - 1991	BLOCK	FOR - FOR	VA-46924	VA-13567	384	
3-SERIES	E36	04/91 - ON	BLOCK	PAD - PAD	VA-57830	VA-13700	385	
3-SERIES	(SOME)		BLOCK	FOR - FOR	VA-46924	VA-13567	384	OE: 64.518.391.209
5-SERIES	E28	1975 - 1982	BLOCK	FOR - FOR	VA-46528	VA-13528	383	OE: 64.111.363.581
5-SERIES	E34	02/89 - on	BLOCK	PAD - PAD	VA-57830	VA-13700	385	
5-SERIES	E39		BLOCK	PAD - PAD	VA-57693		385	OE: 64.118.371.459
7-SERIES	E23	TO - 09/85	BLOCK	FOR - FOR	VA-46528	VA-13528	383	
7-SERIES	E23	09/85 - ON	BLOCK	FOR - FOR	VA-46924	VA-13567	384	
7-SERIES	E32	TO - 07/94	BLOCK	PAD - PAD	VA-57830	VA-13700	385	
7-SERIES	E38		BLOCK	PAD - PAD	VA-57830	VA-13700	385	
8-SERIES	E31	04/94 - ON	BLOCK	PAD - PAD	VA-57830	VA-13700	385	
SOME	EARLY MODELS		BLOCK	FOR - FOR	VA-46528	VA-13520	383	OE: 64-111-363-581
SOME	LATE MODELS		BLOCK	PAD - PAD	VA-57830	VA-13700	385	
CAB - AIRE								
MOST			STD. - EXT.	MF - MF	VA-13438		379	OE: 340016
CASE - I-H								
TRACTORS	(SOME)		STD. - INT.	MF - MF	VA-13420		379	
TRACTORS	912		STD. - EXT.	MF - MF	VA-13438		379	
TRACTORS	2290		STD. - EXT.	MF - MF	VA-13438		379	
TRACTORS	SOME, (INC. HEADERS)		STD. - EXT.	MIOR - MIOR	VA-34637	VA-13480	382	
TRACTORS	SOME, (INC. HEADERS)		STD. - EXT.	MIOR - MIOR	VA-34691	VA-13488	382	
TRACTORS	SOME, (INC. HEADERS)		BLOCK	FOR - FOR	VA-46560	VA-13730	383	
TRACTORS	SOME, (INC. HEADERS)		BLOCK	FOR - FOR	VA-46875	VA-13575	383	
TRACTORS	SOME		BLOCK	FOR - FOR	VA-46924	VA-13567	384	OE: 98370G, 386535A1

Note : To ensure compatability and retain system performance, check the specifications on pages 367-368 against OEM specifications.

TX Valve Application Guide

Application Guide by Vehicle Make / Model

Vehicle	Model / Code	Year	Type	Fittings	Part No.	S/Sedes	Page	Other / OEM Reference
CATERPILLAR								
MOST MODELS	WITH FLARE VALVE		STD. - EXT.	MF - MF	VA-13438		379	OE: 1P 6526
MOST MODELS	WITH O-RING VALVE		STD. - EXT.	MIOR - MIOR	VA-34464	VA-13470	381	OE: 2G 0401
MOST MODELS	WITH BLOCK VALVE		BLOCK	FOR - FOR	VA-46528	VA-13528	383	WITH RED DOT
320	EXCAVATOR		STD. - INT.	MIOR - MIOR	VA-27687	VA-13455	380	OE: 5i 3573
CHRYSLER								
JEEP	CHEROKEE		BLOCK	FOR - FOR	VA-46542	VA-13742	383	OE: 55036189
JEEP	CHEROKEE	1994 - 1996	BLOCK	FOR - FOR	VA-46875	VA-13575	383	
JEEP	GRAND CHEROKEE	03/96 - ON	STD. - EXT.	MIOR - MIOR	VA-34464	VA-13470	381	
NEON		06/96 - ON	BLOCK	PAD - PAD	VA-52714	VA-13714	384	
VALIANT	VG, VM		STD. - EXT.	MIOR - MIOR	VA-34489	VA-13460	381	OE: 2936469 (Discont.)
VOYAGER	GS	02/97 - 04/01	BLOCK	PAD - PAD	VA-59965	VA-13718	385	
CITROEN								
XANTIA		03/93 - ON	BLOCK	PAD - PAD	VA-52947	VA-13960	384	
XM		06/89 - ON	BLOCK	PAD - PAD	VA-52947	VA-13960	384	
COOLTEMP								
MOST			STD. - INT.	MIOR - MIOR	VA-27494	VA-13457	380	COMPACT ASSEMBLY
DAEWOO								
CIELO, 1.5i		TO - 07/97	Orifice Tube		VA-10270		365	
LANOS		1997 - 03/03	BLOCK	PAD - PAD	VA-52956		new	
LEGANZA		1997 - ON	BLOCK	PAD - PAD	VA-52956		new	
MATIZ		10/99 - 06/02	STD. - EXT.	MIOR - MIOR	VA-36472	VA-13472	382	METRIC M16 - M20
NUBIRA			BLOCK	PAD - PAD	VA-52956		new	
DAIHATSU								
APPLAUSE		10/89 - 1993	BLOCK	PAD - PAD	VA-49824	VA-13824	384	R12
APPLAUSE		02/94 - 05/00	BLOCK	PAD - PAD	VA-48865	VA-13865	384	R134a
CHARADE			STD. - INT.	MIOR - MIOR	VA-25447	VA-13447	380	R12 No.5 MIOR INLET
CHARADE		1982 - ON	STD. - INT.	MIOR - MIOR	VA-27140		380	R12
CHARADE		1984 - 1985	STD. - INT.	MIOR - MIOR	VA-25447	VA-13447	380	R12 No.5 MIOR INLET
CHARADE	G100, G102	02/87 - 12/93	STD. - INT.	MIOR - MIOR	VA-25510	VA-13448	380	R12 No.5 MIOR INLET
CHARADE	G200, G202, G203	03/93 - ON	BLOCK	PAD - PAD	VA-48865	VA-13865	384	R134a
DELTA	V10, V20, V30	1980 - ON	STD. - INT.	MIOR - MIOR	VA-25447	VA-13447	380	R12 No.5 MIOR INLET
DELTA	V67, V68, V107, V108	09/84 - ON	STD. - INT.	MIOR - MIOR	VA-25447	VA-13447	380	R12 No.5 MIOR INLET
FEROZA	F300, F310	11/88 - 08/93	BLOCK	PAD - PAD	VA-49824	VA-13824	384	R12
FEROZA	F300, F310	09/93 - ON	BLOCK	PAD - PAD	VA-48865	VA-13865	384	R134a
HANDIVAN	L60V	1981 - ON	STD. - INT.	MIOR - MIOR	VA-25447	VA-13447	380	R12 No.5 MIOR INLET
HI - JET	S75	1984 - ON	STD. - INT.	MIOR - MIOR	VA-25447	VA-13447	380	R12 No.5 MIOR INLET
MIRA	L200, L201		BLOCK	PAD - PAD	VA-49824	VA-13824	384	R12
MIRA	L200	TO - 04/95	BLOCK	PAD - PAD	VA-48865		384	R134a
PYZAR	G301, G303	02/97 - ON	BLOCK	PAD - PAD	VA-48865	VA-13865	384	R134a
ROCKY			STD. - INT.	MIOR - MIOR	VA-25447	VA-13447	380	R12 No.5 MIOR INLET
TERIOS	METRIC	1999 - ON	REV. - INT.	MIOR - MIOR	VA-30952		380	R134a M16-M22 FTGS,
FENDT								
FAVORIT			BLOCK.	PAD - PAD	VA-57780	VA-13780	385	
FORD								
CAPRI	SA30, SB30	12/88 - ON	STD. - INT.	MIOR - MIOR	VA-25447	VA-13447	380	R12 No.5 MIOR INLET
CAPRI	SA86, SB86, SC86	09/90 - 1994	REV. - EXT.	MIOR - MIOR	VA-33178	VA-13464	381	No.5 MIOR INLET
COURIER	DIESEL	1980 - 84	STD. - INT.	MIOR - MIOR	VA-30940	VA-13446	380	R12 METRIC M16 - M20
COURIER		1978 - 1985	STD. - INT.	MF - MF	VA-13415		379	
COURIER		06/88 - ON	STD. - INT.	MIOR - MIOR	VA-25447	VA-13447	380	R12 No.5 MIOR INLET
COURIER		1991 - 1993	STD. - EXT.	MIOR - MIOR	VA-34464	VA-13470	381	
COURIER		03/94 - ON	REV. - EXT.	MIOR - MIOR	VA-33178	VA-13464	381	R134a No.5 MIOR INLET
ECONOVAN	EARLY		STD. - INT.	MF - MF	VA-13415		379	
ECONOVAN		01/94 - ON	REV. - EXT.	MIOR - MIOR	VA-33178	VA-13464	381	R134a No.5 MIOR INLET

Note : To ensure compatability and retain system performance, check the specifications on pages 367-368 against OEM specifications.

TX Valve Application Guide

Application Guide by Vehicle Make / Model

Vehicle	Model / Code	Year	Type	Fittings	Part No.	S/Sedes	Page	Other / OEM Reference
FORD ... cont'd								
FAIRLANE	ZJ, ZK		BLOCK	FOR - FOR	VA-46875	VA-13575	383	OE: C80Z 19849A
FAIRLANE	ZL		BLOCK	PAD - PAD	VA-54592	VA-13592	385	OE: XF19849A
FAIRLANE	NA, NC	TO - 02/92	BLOCK	PAD - PAD	VA-54598	VA-13598	385	OE: EA19849AA
FAIRLANE	NC	02/92 - ON	BLOCK	PAD - PAD	VA-54610	VA-13610	385	OE: EE19849A
FALCON	XA - XE		BLOCK	FOR - FOR	VA-46875	VA-13575	383	OE: C80Z 19849A
FALCON	XF - XG		BLOCK	PAD - PAD	VA-54592	VA-13592	385	OE: XF19849A
FALCON	EA, EB	TO - 02/92	BLOCK	PAD - PAD	VA-54598	VA-13598	385	OE: EA19849AA
FALCON	EB II, ED, EF, EL	02/92 - ON	BLOCK	PAD - PAD	VA-54610	VA-13610	385	OE: EE19849A
FALCON	AU	09/98 - 09/02	Orifice Tube		VA-10220		365	colour code: orange
FALCON	BA	09/02 - ON	Orifice Tube		VA-10224		365	colour code: red
FESTIVA	WA	06/91 - ON	STD. - INT.	MIOR - MIOR	VA-27494	VA-13457	380	
FESTIVA	WA	1993 - 03/94	REV. - EXT.	MIOR - MIOR	VA-33178	VA-13464	381	No.5 MIOR INLET
FESTIVA	WB, WD	04/94 - 12/97	REV. - EXT.	MIOR - MIOR	VA-35462	VA-13462	382	METRIC M16 - #8
LASER	KA, KB, KC, KE, KF	1982 - 1990	STD. - INT.	MIOR - MIOR	VA-25447	VA-13447	380	R12 No.5 MIOR INLET
LASER	KF - KH	1990 - 1994	REV. - EXT.	MIOR - MIOR	VA-33174	VA-38100	381	No.5 MIOR INLET
LASER	KJ, KL	1994 - 1998	REV. - EXT.	MIOR - MIOR	VA-36468	VA-38460	382	METRIC M16-M20
LASER	KN, KQ	03/99 - ON	REV. - EXT.	MIOR - MIOR	VA-33178	VA-13464	381	No.5 MIOR INLET
LOUISVILLE			STD. - INT.	MIOR - MIOR	VA-25447	VA-13447	380	No.5 MIOR INLET
LOUISVILLE	SOME		BLOCK	FOR - FOR	VA-46528	VA-13528	383	
MAVERICK	SOME EARLY MODELS		BLOCK	PAD - PAD	VA-52915	VA-13544	384	
MAVERICK	WITH METRIC FITTINGS		REV. - EXT.	MIOR - MIOR	VA-36472	VA-13472	382	
METEOR	GA - GC		STD. - INT.	MIOR - MIOR	VA-25447	VA-13447	380	No.5 MIOR INLET
RAIDER		1993 - ON	REV. - EXT.	MIOR - MIOR	VA-33178	VA-13464	381	No.5 MIOR INLET
TELSTAR	AR	1983 - 1985	STD. - EXT.	MIOR - MIOR	VA-34123		381	
TELSTAR	AR - AS	1983 - 1987	STD. - INT.	MIOR - MIOR	VA-25447	VA-13447	380	No.5 MIOR INLET
TELSTAR	AT - AV	1987 - ON	STD. - EXT.	MIOR - MIOR	VA-37477	VA-13477	383	METRIC M14 - M20
TRADER		1993 - ON	STD. - EXT.	MIOR - MIOR	VA-34464	VA-13470	381	
TRUCKS	(SOME)		BLOCK	FOR - FOR	VA-46560	VA-13730	383	
FREIGHTLINER								
SOME	WITH FACTORY AIR		BLOCK	FOR - FOR	VA-46875	VA-13575	383	
SOME	WITH RED DOT		BLOCK	FOR - FOR	VA-46528	VA-13528	383	
GENERAL MOTORS HOLDEN								
APOLLO	JK - JL		STD. - INT.	MIOR - MIOR	VA-25510	VA-13448	380	R12 No.5 MIOR INLET
APOLLO	JM - JP		BLOCK	PAD - PAD	VA-48865	VA-13865	384	R134a
ASTRA	LB - LC D- KIKI (ZEXEL)	1984 - 1986	BLOCK	FOR - FOR	VA-46560	VA-13730	383	OE: 0-7431
ASTRA	LD WITH AIR INTERN.	1986 - 1991	STD. - INT.	MIOR - MIOR	VA-27494	VA-13457	380	
ASTRA	TR		BLOCK	PAD - PAD	VA-57780	VA-13753	385	
BARINA	MB, MH N-DENSO	1985 - 1994	STD. - INT.	MIOR - MIOR	VA-25447	VA-13447	380	R12 No.5 MIOR INLET
BARINA	MF WITH AIR INTERN.		REV. - EXT.	MIOR - MIOR	VA-33178	VA-13464	381	R12 No.5 MIOR INLET
BARINA	MH N-DENSO	1994 - ON	STD. - INT.	MIOR - MIOR	VA-27494	VA-13457	380	R134a
BARINA	SB 90° TYPE VALVE		REV. - EXT.	MIOR - MIOR	VA-33178	VA-13464	381	No.5 MIOR INLET
BARINA	SB BLOCK VALVE		BLOCK	PAD - PAD	VA-57780	VA-13753	385	
CALIBRA		1991 - 1994	Orifice Tube		VA-10244		365	colour code: red
CAMIRA	JB - JE		STD. - EXT.	MIOR - MIOR	VA-34691	VA-13488	382	
COMBO	REFER TO SB BARINA							
COMMODORE	VB - VC (HARRISON)		STD. - EXT.	MIOR - MIOR	VA-34867	VA-13496	382	
COMMODORE	VB - VC (HARRISON)		Orifice Tube		VA-10270		365	CCOT SYSTEM
COMMODORE	VB - VC (AIR-INT)		STD. - EXT.	MIOR - MIOR	VA-34691	VA-13488	382	OE: S618522
COMMODORE	VC - VH (AIR-INT)		BLOCK	FOR - FOR	VA-46875	VA-13575	383	OE: 06-70044
COMMODORE	VK		STD. - EXT.	MIOR - MIOR	VA-34691	VA-13488	382	OE: S6-18528
COMMODORE	VL		STD. - EXT.	MIOR - MIOR	VA-34464	VA-13470	381	OE: S6-18524
COMMODORE	VN - VP - VQ		Orifice Tube		VA-10250		365	colour code: blue
COMMODORE	VR - VS		BLOCK	PAD - PAD	VA-57830	VA-13700	385	
COMMODORE	VT, VX, VY		BLOCK	PAD - PAD	VA-52838	VA-13736	384	
DROVER	QB		STD. - INT.	MIOR - MIOR	VA-25447	VA-13447	380	R12 No.5 MIOR INLET
FRONTERA	UT		REV. - EXT.	MIOR - MIOR	VA-33178	VA-13464	381	No.5 MIOR INLET
GEMINI	TF, TG		STD. - EXT.	MF - MF	VA-13438		379	
GEMINI	RB		REV. - EXT.	MIOR - MIOR	VA-34464	VA-13470	381	
JACKAROO		1982 - 1988	STD. - INT.	MF - MF	VA-13415		379	
JACKAROO		1988 - 1992	STD. - INT.	MIOR - MIOR	VA-27494	VA-13457	380	
JACKAROO		1992 - 1994	STD. - EXT.	MIOR - MIOR	VA-34464	VA-13470	381	
JACKAROO	WITH AIR INTERN.	1994 - ON	REV. - EXT.	MIOR - MIOR	VA-33178	VA-13464	381	No.5 MIOR INLET
JACKAROO	WITH N-DENSO	1997 - ON	BLOCK	PAD - PAD	VA-48865	VA-13865	384	R134a
HOLDEN	HQ - HZ		STD. - EXT.	MIOR - MIOR	VA-34867	VA-13496	382	OE: 6551441
HOLDEN	HJ - HZ		POAST	MIOR - MIOR	VA-10565	N - A	365	OE: 6551429
HOLDEN	WB		Orifice Tube		VA-10270		365	CCOT SYSTEM

Note : To ensure compatability and retain system performance, check the specifications on pages 367-368 against OEM specifications.

TX Valve Application Guide

Application Guide by Vehicle Make / Model

Vehicle	Model / Code	Year	Type	Fittings	Part No.	S/Sedes	Page	Other / OEM Reference
GENERAL MOTORS HOLDEN . . cont.								
NOVA	LE - LF		STD. - INT.	MIOR - MIOR	VA-25447	VA-13447	380	R12 No.5 MIOR INLET
NOVA	LF with R134a		STD. - INT.	MIOR - MIOR	VA-31214	VA-13449	380	R134a METRIC M16 - M22
NOVA	LG		BLOCK	PAD - PAD	VA-48865	VA-13865	384	R134a
RODEO		EARLY	STD. - INT.	MF - MF	VA-13415		379	
RODEO		1988 - 1992	STD. - INT.	MIOR - MIOR	VA-27494	VA-13457	380	
RODEO		1992 - ON	STD. - EXT.	MIOR - MIOR	VA-34464	VA-13470	381	OE: S6-18524
RODEO		1994 - 2003	REV. - EXT.	MIOR - MIOR	VA-33178	VA-13464	381	No.5 MIOR INLET
STATESMAN	HQ - HZ		STD. - EXT.	MIOR - MIOR	VA-34867	VA-13496	382	OE: 6551441
STATESMAN	HJ - HZ		POAST	MIOR - MIOR	VA-10565	N - A	365	OE: 6551429
STATESMAN	WB		Orifice Tube		VA-10270		365	CCOT SYSTEM
TORANA	(MODELS WITH VIR)		VIR	MIOR - MIOR	VA-65125	N - A	386	
VECTRA	JR, JS	06/97 - ON	BLOCK	PAD - PAD	VA-51733		new	
HINO								
HINO	BU36		STD. - INT.	MIOR - MIOR	VA-25447	VA-13447	380	R12 No.5 MIOR INLET
HINO	FC144		STD. - INT.	MIOR - MIOR	VA-25447	VA-13447	380	R12 No.5 MIOR INLET
HINO	FD W06E	1991 - ON	STD. - INT.	MIOR - MIOR	VA-25510	VA-13448	380	R12 No.5 MIOR INLET
HINO	FD, FE, FF, GD H07D	1991 - ON	STD. - INT.	MIOR - MIOR	VA-25510	VA-13448	380	R12 No.5 MIOR INLET
HINO	FD; GD164, GD166		STD. - INT.	MIOR - MIOR	VA-25510	VA-13448	380	R12 No.5 MIOR INLET
HINO	FD171		STD. - INT.	MIOR - MIOR	VA-25447	VA-13447	380	R12 No.5 MIOR INLET
HINO	FD3W, FT3W		STD. - INT.	MIOR - MIOR	VA-25510	VA-13448	380	R12 No.5 MIOR INLET
HINO	FF172, 173, 177		STD. - INT.	MIOR - MIOR	VA-25447	VA-13447	380	R12 No.5 MIOR INLET
HINO	FF192, 193, 197		STD. - INT.	MIOR - MIOR	VA-25447	VA-13447	380	R12 No.5 MIOR INLET
HINO	FS270		STD. - INT.	MIOR - MIOR	VA-25447	VA-13447	380	R12 No.5 MIOR INLET
HINO	GH		STD. - INT.	MIOR - MIOR	VA-25510	VA-13448	380	R12 No.5 MIOR INLET
HINO	GS221		STD. - INT.	MIOR - MIOR	VA-25447	VA-13447	380	R12 No.5 MIOR INLET
HINO	GT173, GT175		STD. - INT.	MIOR - MIOR	VA-25510	VA-13448	380	R12 No.5 MIOR INLET
HINO	SS330		STD. - INT.	MIOR - MIOR	VA-25510	VA-13448	380	R12 No.5 MIOR INLET
HINO MERLIN	FC3W		STD. - INT.	MIOR - MIOR	VA-25447	VA-13447	380	R12 No.5 MIOR INLET
HONDA								
ACCORD		1985 - 1989	REV. - INT.	MIOR - MIOR	VA-27668	VA-13453	380	No.6 MIOR INLET
ACCORD		1991 - 1993	REV. - EXT.	MIOR - MIOR	VA-34464	VA-13470	381	No.6 MIOR INLET
ACCORD	WITH BLOCK VALVE	1993 - ON	BLOCK	PAD - PAD	VA-48865	VA-13865	384	
ACCORD		1994 - ON	REV. - EXT.	MIOR - MIOR	VA-33178	VA-13464	381	No.5 MIOR INLET
CIVIC		1984 - 1993	REV. - INT.	MIOR - MIOR	VA-27668	VA-13453	380	
CIVIC		1994 - ON	REV. - EXT.	MIOR - MIOR	VA-33178	VA-13464	381	No.5 MIOR INLET
INTEGRA		1986 - 1988	REV. - INT.	MIOR - MIOR	VA-27668	VA-13453	380	
LEGEND		1990 - 1991	STD. - INT.	MIOR - MIOR	VA-25510	VA-13448	380	R12 No.5 MIOR INLET
ODYSSEY		2000 - ON	REV. - EXT.	MIOR - MIOR	VA-33169		381	No.5 MIOR INLET
PRELUDE		1983 - 1987	REV. - INT.	MIOR - MIOR	VA-27668	VA-13453	380	
PRELUDE		1987 - 1991	STD. - EXT.	MIOR - MIOR	VA-34489	VA-13460	381	
PRELUDE	METRIC	1992 - 1994	STD. - EXT.	MIOR - MIOR	VA-36472	VA-13472	382	METRIC M16 - M20
HYUNDAI								
EXCEL		1987 - 1990	STD. - EXT.	MIOR - MIOR	VA-34464	VA-13470	381	OE: 97623-2100
EXCEL		1995 -	REV. - EXT.	MIOR - MIOR	VA-36356	VA-13456	382	METRIC M16 - M20
EXCEL		1996 - ON	BLOCK	PAD - PAD	VA-48902	VA-13738	384	METRIC FITTINGS
LANTRA		1996 - ON	BLOCK	PAD - PAD	VA-48902	VA-13738	384	METRIC FITTINGS
INTERNATIONAL								
ACCO	SOME		STD. - INT.	MIOR - MIOR	VA-27462	VA-13450	380	OE: 3262159R91
9670	SERIES		STD. - EXT.	MIOR - MIOR	VA-34464	VA-13470	381	OE: 469475C1
FLEETSTAR	SOME		STD. - INT.	MF - MF	VA-13415		379	
IVECO	IHA 1850		STD. - EXT.	MIOR - MIOR	VA-34464	VA-13470	381	OE: 469475C1
PAYSTAR			STD. - EXT.	MF - MF	VA-13438		379	OE: 66398-C1
TRANSTAR	SOME		STD. - INT.	MF - MF	VA-13415		379	
TRANSTAR	SOME		STD. - EXT.	MF - MF	VA-13438		379	OE: 66398-C1
S-LINE	EXCEPT DT466		STD. - EXT.	MIOR - MIOR	VA-34464	VA-13470	381	OE: 469475-C1
T-LINE	EXCEPT DT466		STD. - EXT.	MIOR - MIOR	VA-34464	VA-13470	381	OE: 469475-C1
T-LINE	2670		STD. - EXT.	MIOR - MIOR	VA-34867	VA-13496	382	
SOME			STD. - EXT.	MIOR - MIOR	VA-34691	VA-13488	382	OE: 118305-C3
ISUZU								
FSR, FTR		1994 -	REV. - EXT.	MIOR - MIOR	VA-33178	VA-13464	381	No.5 MIOR INLET
FTR		04/96 - ON	BLOCK	FOR - FOR	VA-49824	VA-13824	384	
NPR		1994	REV. - EXT.	MIOR - MIOR	VA-36461	VA-38400	382	METRIC M16-M20
NPS		1996 - ON	REV. - EXT.	MIOR - MIOR	VA-36461	VA-38400	382	METRIC M16-M20

Note : To ensure compatability and retain system performance, check the specifications on pages 367-368 against OEM specifications.

TX Valve Application Guide

Application Guide by Vehicle Make / Model

Vehicle	Model / Code	Year	Type	Fittings	Part No.	S/Sedes	Page	Other / OEM Reference
ISEKI								
TA550, TA545			STD. - INT.	MIOR - MIOR	VA-30940	VA-13446	380	METRIC M16 - M20
JAGUAR								
XJ6	SERIES II (LATE)		STD. - EXT.	MIOR - MIOR	VA-34662	VA-13484	382	OE: CAC - 2423
XJ6	SERIES III	1985 - 1991	BLOCK	FOR - FOR	VA-46924	VA-13567	384	
XJS			STD. - EXT.	MIOR - MIOR	VA-34662	VA-13484	382	OE: CAC - 2423
XJ40		TO - 1992	STD. - EXT.	MIOR - MIOR	VA-34691	VA-13488	382	
XJ40		1992 - ON	BLOCK	FOR - FOR	VA-46924	VA-13567	384	
XJ40	WITH BOLT-ON VALVE		BLOCK	PAD - PAD	VA-54592	VA-13592	385	
JOHN DEERE								
TRACTORS	SOME WITH FLARE		STD. - EXT.	MF - MF	VA-13434		379	OE: AH80191
TRACTORS	SOME WITH FLARE		STD. - INT.	MF - MF	VA-13415		379	
TRACTORS	SOME WITH O-RING		STD. - EXT.	MIOR - MIOR	VA-34464	VA-13470	381	OE: AT60277
TRACTORS	MOST WITH O-RING		STD. - EXT.	MIOR - MIOR	VA-34637	VA-13480	382	OE: AR58482, AH140818
TRACTORS	WITH BLOCK VALVE		BLOCK	FOR - FOR	VA-46924	VA-13567	384	OE: AH122867, AH137702
TRACTORS	WITH BLOCK VALVE		BLOCK	PAD - PAD	VA-57830	VA-13700	385	
KENWORTH								
K100; BRUTE	C500 WITH RED DOT		BLOCK	FOR - FOR	VA-46528	VA-13528	383	
K100	BERGSTROM		STD. - EXT.	MIOR - MIOR	VA-34464	VA-13470	381	OE: 576270
K100, C500			BLOCK	FOR - FOR	VA-46983	VA-13770	384	
W900	WITH RED DOT		STD. - EXT.	MF - MF	VA-13434		379	
KIA								
SPORTAGE		1997 - ON	REV. - EXT.	MIOR - MIOR	VA-36356	VA-13456	382	METRIC M16 - M20
SOME	WITH BLOCK VALVE		BLOCK	PAD - PAD	VA-48902	VA-13738	384	
KOMATSU								
PC200			BLOCK	PAD - PAD	VA-48865	VA-13865	384	R134a
KYSOR								
SOME	SOME EARLY MODELS		STD. - INT.	MF - MF	VA-13415		379	OE: 404000
BACKPAK, BUNK	KOMBO		BLOCK	FOR - FOR	VA-46528	VA-13528	383	
E20000			STD. - EXT.	MF - MF	VA-13434		379	OE: 404021
HD1000, HD2000	INCLUDING KOMBO		BLOCK	FOR - FOR	VA-46528	VA-13528	383	
JUMPSEAT	KOMBO		BLOCK	FOR - FOR	VA-46528	VA-13528	383	
KA200	EVAPORATOR		STD. - EXT.	MIOR - MIOR	VA-34691	VA-13488	382	OE: 404073
KA300	ROOFTOP		STD. - EXT.	MIOR - MIOR	VA-34691	VA-13488	382	OE: 404073
KA700	EVAPORATOR		BLOCK	FOR - FOR	VA-46528	VA-13528	383	OE: 04098
KK-315	KOMBO		BLOCK	FOR - FOR	VA-46528	VA-13528	383	
SOME MODELS			BLOCK	FOR - FOR	VA-46983	VA-13770	384	OE: 404217
SOME MODELS	WITH O-RING		STD. - EXT.	MIOR - MIOR	VA-34867	VA-13496	382	OE: 404111
MACK								
SOME	WITH KYSOR		STD. - EXT.	MIOR - MIOR	VA-34464	VA-13470	381	
SOME	WITH KYSOR		BLOCK	FOR - FOR	VA-46875	VA-13575	383	
SOME	WITH RED DOT		BLOCK	FOR - FOR	VA-46983	VA-13770	384	
MASSEY FERGUSON								
SOME	WITH BLOCK VALVE		BLOCK	FOR - FOR	VA-46560	VA-13730	383	OE: 1075118 M91
SOME	WITH BLOCK VALVE		BLOCK	FOR - FOR	VA-46875	VA-13575	383	OE: 284238 M1
MOST	WITH STD. VALVE		STD. - EXT.	MIOR - MIOR	VA-34637	VA-13480	382	OE: 0388918
MAZDA								
121			STD. - INT.	MIOR - MIOR	VA-25447	VA-13447	380	No.5 MIOR INLET
121		11/90 - 01/94	REV. - EXT.	MIOR - MIOR	VA-33178	VA-13464	381	No.5 MIOR INLET
121, METRO	(Australian Air)	1994 - ON	STD. - INT.	MIOR - MIOR	VA-27494	VA-13457	380	
323	BD - BF	1982 - 1990	STD. - INT.	MIOR - MIOR	VA-25447	VA-13447	380	No.5 MIOR INLET
323		1986 - ON	STD. - EXT.	MIOR - MIOR	VA-34464	VA-13470	381	OE: 85-0254
323		1990 - 1994	REV. - EXT.	MIOR - MIOR	VA-33174	VA-38100	381	No.5 MIOR INLET
323		1994 - ON	REV. - EXT.	MIOR - MIOR	VA-36468	VA-38460	382	METRIC M16-M20
323		1998 -	REV. - EXT.	MIOR - MIOR	VA-33178	VA-13464	381	No.5 MIOR INLET

Note : To ensure compatability and retain system performance, check the specifications on pages 367-368 against OEM specifications.

TX Valve Application Guide

Application Guide by Vehicle Make / Model

Vehicle	Model / Code	Year	Type	Fittings	Part No.	S/Sedes	Page	Other / OEM Reference
MAZDA . . . cont'd								
626	WITH FLARE	1979 - 1981	STD. - INT.	MF - MF	VA-13415		379	OE: 3-3683
626		1983 - 1985	STD. - EXT.	MIOR - MIOR	VA-34123		381	
626	GC	07/83 - 10/87	STD. - INT.	MIOR - MIOR	VA-25447	VA-13447	380	No.5 MIOR INLET
626	GD	1990 - ON	STD. - EXT.	MIOR - MIOR	VA-37477	VA-13477	383	METRIC M14 - M20
626		1996 - ON	REV. - EXT.	MIOR - MIOR	VA-33178	VA-13464	381	No.5 MIOR INLET
929		02/80 - ON	STD. - EXT.	MIOR - MIOR	VA-33138		381	No.5 MIOR INLET
929		1982 - 1987	STD. - INT.	MIOR - MIOR	VA-25510	VA-13448	380	No.5 MIOR INLET
ASTINA		1990 - 1994	REV. - EXT.	MIOR - MIOR	VA-33174	VA-38100	381	No.5 MIOR INLET
ASTINA		1994 - ON	REV. - EXT.	MIOR - MIOR	VA-36468	VA-38460	382	METRIC M16-M20
B SERIES	DIESEL-KIKI	1980 - 1984	STD. - INT.	MIOR - MIOR	VA-30940	VA-13446	380	METRIC M16 - M20
B SERIES	WITH FLARE	1982 - 1985	STD. - INT.	MF - MF	VA-13415		379	OE: 3-3683
B SERIES		1985 - 1997	STD. - INT.	MIOR - MIOR	VA-25447	VA-13447	380	No.5 MIOR INLET
B SERIES		1997 - ON	REV. - EXT.	MIOR - MIOR	VA-33178	VA-13464	381	No.5 MIOR INLET
E SERIES		1980 - 1985	STD. - INT.	MF - MF	VA-13415		379	OE: 3-3683
E SERIES		1986 - 1992	STD. - INT.	MIOR - MIOR	VA-27494	VA-13457	380	
E SERIES		1992 - ON	REV. - EXT.	MIOR - MIOR	VA-33178	VA-13464	381	No.5 MIOR INLET
MPV		1993 - 1999	STD. - INT.	COR - COR	VA-31214	VA-13449	380	METRIC, CAPTIVE O-R
MX5		1990 - 1994	STD. - INT.	MIOR - MIOR	VA-25447	VA-13447	380	No.5 MIOR INLET
MX5		1994 - ON	STD. - INT.	COR - COR	VA-31214	VA-13449	380	METRIC, CAPTIVE O-R
RX7		1983 - 1985	STD. - EXT.	MIOR - MIOR	VA-34464	VA-13470	381	OE: 3-3681
RX7		1986 - 1989	STD. - INT.	MIOR - MIOR	VA-25447	VA-13447	380	No.5 MIOR INLET
RX7			REV. - INT.	MIOR - MIOR	VA-27668	VA-13453	380	
TRUCKS	T SERIES	T0 - 10/89	STD. - INT.	MF - MF	VA-13415		379	
TRUCKS	T SERIES	11/89 - ON	STD. - INT.	MIOR - MIOR	VA-27462	VA-13450	380	
MERCEDES								
SPRINTER	SOME		BLOCK	PAD - PAD	VA-52915	VA-13544	384	
SPRINTER	SOME		BLOCK	FOR - FOR	VA-46875	VA-13575	383	
VITO	SOME		BLOCK	PAD - PAD	VA-52915	VA-13544	384	
VITO	SOME		BLOCK	FOR - FOR	VA-46875	VA-13575	383	
W107			STD. - EXT.	MF - MF	VA-13434		379	
W108, W109			STD. - EXT.	MF - MF	VA-13434		379	
W114, 115, 116		1969 - ON	STD. - EXT.	MF - MF	VA-13434		379	
W123		TO - 1980	BLOCK	FOR - FOR	VA-46528	VA-13528	383	OE: 1238300384/1184
W123		1980 - ON	BLOCK	FOR - FOR	VA-46924	VA-13567	384	
W124		TO - 1992	BLOCK	PAD - PAD	VA-57984	VA-13753	385	
W126		1981 - 1991	BLOCK	FOR - FOR	VA-46924	VA-13567	384	OE: 1268300284/384/584
W140		TO - 1992	BLOCK	PAD - PAD	VA-57984	VA-13753	385	
W140		1991 - ON	BLOCK	PAD - PAD	VA-57912	VA-13750	385	
W201		TO - 1992	BLOCK	PAD - PAD	VA-57984	VA-13753	385	
W201	190	1992 - ON	BLOCK	PAD - PAD	VA-57912	VA-13750	385	OE: 2018300384/484
W202	C180, C220	1994 - ON	BLOCK	PAD - PAD	VA-57912	VA-13750	385	
MITSUBISHI								
COLT RA - RB	(SEE VA-13434 ALSO)		STD. - INT.	MF - MF	VA-13415		379	
COLT RA - RE	(SEE VA-13415 ALSO)		STD. - EXT.	MF - MF	VA-13434		379	
CORDIA	(ALL)		STD. - INT.	MF - MF	VA-13415		379	
EXPRESS	SF, SH	08/86 - 06/94	STD. - INT.	MIOR - MIOR	VA-27494	VA-13457	380	
EXPRESS	SJ	10/94 - ON	REV. - EXT.	MIOR - MIOR	VA-33178	VA-13464	381	No.5 MIOR INLET
EXPRESS	WA	06/94 - ON	REV. - EXT.	MIOR - MIOR	VA-36461		382	METRIC M16 - M20
GALANT	HG, HH	11/88 - 11/92	STD. - EXT.	MIOR - MIOR	VA-34464	VA-13470	381	
L200			STD. - INT.	MF - MF	VA-13415		379	
L300	EARLY, FLARE VALVE	1980 - 1985	STD. - INT.	MF - MF	VA-13415		379	
L300		1986 - ON	REFER TO EXPRESS / STARWAGON					
LANCER	CA, CB AND GSR		STD. - EXT.	MIOR - MIOR	VA-34464	VA-13470	381	
LANCER	CC AIR INTERN.		REV. - EXT.	MIOR - MIOR	VA-33178	VA-13464	381	R12 No.5 MIOR INLET
LANCER	CC (METRIC)	1992 - 1995	STD. - EXT.	MIOR - MIOR	VA-36472	VA-13472	382	METRIC M16 - M20
LANCER	CE (METRIC)	1996 - 1999	STD. - EXT.	MIOR - MIOR	VA-36472	VA-13472	382	METRIC M16 - M20
MAGNA	TM, TN, TP		STD. - INT.	MIOR - MIOR	VA-25447	VA-13447	380	R12 No.5 MIOR INLET
MAGNA	TR		STD. - INT.	MIOR - MIOR	VA-25510	VA-13448	380	No.5 MIOR INLET
MAGNA	TS		STD. - INT.	COR - COR	VA-31214	VA-13449	380	R134a METRIC M16-M22
MAGNA	TE, TF, TH, TJ	1996 - ON	REV. - EXT.	MIOR - MIOR	VA-33196	VA-13465	381	No.5 MIOR INLET
MIRAGE	CE	1996 - 1999	STD. - EXT.	MIOR - MIOR	VA-36472	VA-13472	382	METRIC M16 - M20
NIMBUS	UF	TO - 1993	STD. - EXT.	MIOR - MIOR	VA-34464	VA-13470	381	
NIMBUS	UF	1994 - ON	REV. - EXT.	MIOR - MIOR	VA-33178	VA-13464	381	No.5 MIOR INLET

Note : To ensure compatability and retain system performance, check the specifications on pages 367-368 against OEM specifications.

TX Valve Application Guide

Application Guide by Vehicle Make / Model

Vehicle	Model / Code	Year	Type	Fittings	Part No.	S/Sedes	Page	Other / OEM Reference
MITSUBISHI . . . cont'd								
PAJERO	NA - NF	1991 - 1994	STD. - INT.	MF - MF	VA-13415		379	
PAJERO	NF - NH		STD. - EXT.	MIOR - MIOR	VA-34464	VA-13470	381	R12
PAJERO	NH (SOME) Air Intern.	1993 - ON	REV. - EXT.	MIOR - MIOR	VA-33178	VA-13464	381	No.5 MIOR INLET
PAJERO	NJ, NK, NL N-Denso		BLOCK	PAD - PAD	VA-48865	VA-13865	384	R134a
SIGMA	GE, GH, GJ, GK (FLARE)		STD. - INT.	MF - MF	VA-13415		379	
SIGMA	GN (O-RING)		STD. - INT.	MIOR - MIOR	VA-25510	VA-13448	380	No.5 MIOR INLET
STARWAGON	SF, SH	08/86 - 06/94	STD. - INT.	MIOR - MIOR	VA-27494	VA-13457	380	R12
STARWAGON	SJ	10/94 - ON	REV. - EXT.	MIOR - MIOR	VA-33178	VA-13464	381	No.5 MIOR INLET
STARWAGON	WA	06/94 - ON	REV. - EXT.	MIOR - MIOR	VA-36461		382	METRIC M16 - M20
TRITON	MH - MJ	10/96 - ON	STD. - INT.	MF - MF	VA-13415		379	
TRITON	MJ (EXT, EQUALIZED)		REV. - EXT.	MIOR - MIOR	VA-33178	VA-13464	381	No.5 MIOR INLET
TRITON	MK		REV. - EXT.	MIOR - MIOR	VA-33196	VA-13465	381	No.5 MIOR INLET
VERADA	REFER TO MAGNA							
NEW HOLLAND								
SOME	WITH BLOCK VALVE		BLOCK	FOR - FOR	VA-46875	VA-13575	383	OE: 620005
TR86, TR99	BLOCK, with service valve		BLOCK	FOR - FOR	VA-46913		383	
NISSAN								
200B		TO - 05/83	STD. - EXT.	MF - MF	VA-13434		379	OE: 0-5362
BLUEBIRD	SERIES-I AND II		BLOCK	FOR - FOR	VA-46560	VA-13730	383	OE: 0-7431
BLUEBIRD	SERIES-III		BLOCK	PAD - PAD	VA-52915	VA-13544	384	OE: 0-7455
BLUEBIRD	U13	04/95 - ON	STD. - EXT.	MIOR - MIOR	VA-36324		382	METRIC M16 - M20
GAZELLE		TO - 01/84	BLOCK	FOR - FOR	VA-46560	VA-13730	383	OE: 0-7431
GAZELLE		01/84 - ON	BLOCK	PAD - PAD	VA-52915	VA-13544	384	OE: 0-7455
MAXIMA	J30	02/90 - 10/93	REV. - EXT.	MIOR - MIOR	VA-35462	VA-13462	382	METRIC M16 - #8
MAXIMA	A32	10/93 - 11/99	BLOCK.	PAD - PAD	VA-52919		new	
MICRA		05/95 - 12/97	REV. - EXT.	MIOR - MIOR	VA-33178	VA-13464	381	No.5 MIOR INLET
NAVARA	D21	TO - 1996	REV. - EXT.	MIOR - MIOR	VA-33178	VA-13464	381	No.5 MIOR INLET
NAVARA	D22	02/97 - ON	REV. - INT.	MIOR - MIOR	VA-31074		380	METRIC M16 - M20
PATHFINDER	D21	TO - 1996	REV. - EXT.	MIOR - MIOR	VA-33178	VA-13464	381	No.5 MIOR INLET
PATROL		TO - 01/84	STD. - INT.	MF - MF	VA-13415		379	
PATROL		01/84 - 01/88	BLOCK	FOR - FOR	VA-46560	VA-13730	383	OE: 0-7431
PATROL	Y60 AIR INTERN.	1988 - ON	REV. - EXT.	MIOR - MIOR	VA-33178	VA-13464	381	No.5 MIOR INLET
PATROL	GU / Y61	01/98 - ON	BLOCK.	PAD - PAD	VA-52919		new	
PATROL	Y60 LATE, DIESEL-KIKI		REV. - EXT.	MIOR - MIOR	VA-36472	VA-13472	382	METRIC M16 - M20
PINTARA		TO - 1989	REV. - EXT.	MIOR - MIOR	VA-35462	VA-13462	382	METRIC M16 - #8
PINTARA		1989 - 1992	BLOCK	PAD - PAD	VA-52915	VA-13544	384	OE: 0-7455
PULSAR	N12	1984 - 1987	BLOCK	FOR - FOR	VA-46560	VA-13730	383	0-7431
PULSAR	N13		STD. - INT.	MIOR - MIOR	VA-27494	VA-13457	380	
PULSAR	N14 (REVERSE ASSY)		REV. - EXT.	MIOR - MIOR	VA-36356	VA-13456	382	METRIC M16 - M20
PULSAR	N14 (METRIC)		STD. - EXT.	MIOR - MIOR	VA-36324		382	METRIC M16 - M20
PULSAR	N15 (INT. EQUALIZED)	10/95 - ON	REV. - INT.	MIOR - MIOR	VA-31074		380	METRIC M16 - M20
PULSAR	N15 (METRIC)		STD. - EXT.	MIOR - MIOR	VA-36324		382	METRIC M16 - M20
SKYLINE	IMPORTED	TO - 1989	REV. - EXT.	MIOR - MIOR	VA-35462	VA-13462	382	METRIC M16 - #8
SKYLINE		1986 - 1990	BLOCK	PAD - PAD	VA-52915	VA-13544	384	OE: 0-7455
TERRANO	WITH AUSTRALIAN AIR		STD. - INT.	MIOR - MIOR	VA-25447	VA-13447	380	No.5 MIOR INLET
URVAN	SOME		BLOCK	FOR - FOR	VA-46560	VA-13730	383	OE: 0-7431
VANETTE	SOME		BLOCK	FOR - FOR	VA-46560	VA-13730	383	OE: 0-7431
PEUGEOT								
205		1989 - ON	BLOCK	FOR - FOR	VA-46875	VA-13575	383	
306			BLOCK	PAD - PAD	VA-57780	VA-13780	385	
405			BLOCK	FOR - FOR	VA-57984	VA-13753	385	
505			BLOCK	FOR - FOR	VA-46960	VA-13560	384	OE: 59-36-1000
PORSCHE								
911, 912, 914, 924			STD. - INT.	MF - MF	VA-13415		379	OE: 70.321.01.409/00.409
928	EARLY		BLOCK	FOR - FOR	VA-46960	VA-13560	384	
928 S4			BLOCK	PAD - PAD	VA-54592	VA-13592	385	
SOME	LATE WITH BLOCK VALVE		BLOCK	FOR - FOR	VA-46924	VA-13567	384	OE: ZVW.231.057
SOME	LATE WITH BLOCK VALVE		BLOCK	FOR - FOR	VA-46875	VA-13575	383	
SOME	LATE WITH BLOCK VALVE		BLOCK	FOR - FOR	VA-46282		383	

Note : To ensure compatability and retain system performance, check the specifications on pages 367-368 against OEM specifications.

TX Valve Application Guide

Application Guide by Vehicle Make / Model

Vehicle	Model / Code	Year	Type	Fittings	Part No.	S/Sedes	Page	Other / OEM Reference
RED DOT								
SOME EARLY R2000, R5045 R7380 ROOFTOPS	MODELS WITH FLARE MOST LATE MODELS LATE R6000, R6100, R9727	LATE	STD. - EXT. BLOCK	MF - MF FOR - FOR	VA-13434 VA-46528 VA-46528 VA-46528		379 383 383 383	OE: 71R8300, 71R8310 OE: 71R8300, 71R8310 OE: 71R8300/4157-0, 71R8310/5-6868-0
SOME OEM	WITH BLOCK VALVE		BLOCK	FOR - FOR	VA-46983	VA-13770	384	OE: 5-7015-0
RENAULT								
18 25i 19 FUEGO			BLOCK	FOR - FOR	VA-46560 VA-46924 VA-57780 VA-46560	VA-13730 VA-13567 VA-13780 VA-13730	383 384 385 383	OE: 2-22576 OE: 2-22576
ROLLS ROYCE								
MOST MODELS SOME SOME WITH POAST VALVE			STD. - EXT. POAST	MIOR - MIOR MIOR - MIOR	VA-34662 VA-10565 VA-34867	VA-13484 N - A VA-13496	382 365 382	OE: 6551445
ROVER								
LANDROVER LANDROVER RANGEROVER ROVER SD1	DISCOVERY DEFENDER, AMC AIR KEIHIN COMP.	1991 - ON TO - 1989 1978 - ON	STD. - INT. STD. - INT. STD. - INT. STD. - INT.	MIOR - MIOR MIOR - MIOR MIOR - MIOR MIOR - MIOR	VA-27462 VA-27462 VA-27687 VA-25447	VA-13450 VA-13450 VA-13455 VA-13447	380 380 380 380	No.5 MIOR INLET
SAAB								
MOST EARLY MODELS 900 (SOME) 900 (SOME) 900 (SOME) 9000 9000 9000 9-5		03/94 - 06/98 TO - 1991 1991 - ON TO - 06/98 11/97 - ON	BLOCK STD. - EXT. BLOCK STD. - EXT. BLOCK STD. - EXT. BLOCK	FOR - FOR MIOR - MIOR PAD - PAD PAD - PAD PAD - PAD PAD - PAD	VA-46875 VA-34464 VA-57780 VA-51781 VA-34662 VA-57780 VA-51781 VA-52947	VA-13575 VA-13470 VA-13780 VA-13781 VA-13484 VA-13780 VA-13781 VA-13960	383 381 385 384 382 385 384 384	OE: 302474 OE: 046-155-016 R134a OE: 6551445 R134a R134a
SAME								
TRACTORS	SOME		BLOCK	FOR - FOR	VA-49824	VA-13824	384	
SANDEN								
ROOFTOPS			STD. - INT.	MF - MF	VA-13415		379	OE: 51515-10040
SIGMA OFF - ROAD								
SOME MODELS SOME MODELS SOME MODELS	WITH DANFOSS #4 WITH DANFOSS #5		STD. - INT. STD. - EXT.	MF - MF MIOR - MF	VA-13420 VA-13445 VA-13445		379 379 379	FOR UR-12 MODEL use VA-10140 orifice FOR UR-23 MODEL use VA-10150 orifice
SUBARU								
IMPREZA FORESTER LIBERTY LIBERTY		04/93 - ON 08/97 - ON 06/89 - 06/94 06/94 - ON	STD. - INT. STD. - INT. BLOCK BLOCK	MIOR - MIOR MIOR - MIOR PAD - PAD PAD - PAD	VA-30940 VA-30940 VA-49824 VA-48865	VA-13446 VA-13446 VA-13824 VA-13865	380 380 384 384	METRIC M16-M20 METRIC M16-M20 R12 R134a
SUZUKI								
SOME ALTO SIERRA SWIFT VITARA VITARA X90	550cc, 800cc	1982 - ON 1987 - ON 1984 - 1994 1984 - 1994 TO - 1995 1995 - ON	STD. - INT. STD. - INT. STD. - INT. STD. - INT. STD. - INT. STD. - INT.	MIOR - MIOR MIOR - MIOR MIOR - MIOR MIOR - MIOR MIOR - MIOR MIOR - MIOR	VA-25447 VA-25447 VA-25447 VA-25447 VA-25510 VA-31214 VA-31214	VA-13447 VA-13447 VA-13447 VA-13447 VA-13448 VA-13449 VA-13449	380 380 380 380 380 380 380	R12 R12 R12 R12 R12 R134a R134a No.5 MIOR INLET No.5 MIOR INLET No.5 MIOR INLET No.5 MIOR INLET No.5 MIOR INLET METRIC M16-M22 METRIC M16-M22

Note : To ensure compatability and retain system performance, check the specifications on pages 367-368 against OEM specifications.

TX Valve Application Guide

Application Guide by Vehicle Make / Model

Vehicle	Model / Code	Year	Type	Fittings	Part No.	S/Sedes	Page	Other / OEM Reference
TOYOTA								
AVALON			BLOCK	PAD - PAD	VA-48865	VA-13865	384	R134a
CAMRY	SV11, SV20, SV21, SV22		STD. - INT.	MIOR - MIOR	VA-25510	VA-13448	380	R12 No.5 MIOR INLET
CAMRY	SXV10, SXV20R		BLOCK	PAD - PAD	VA-48865	VA-13865	384	R134a
CAMRY	MCV20, VCV10, VDV10	02/93 - 08/02	BLOCK	PAD - PAD	VA-48865	VA-13865	384	R134a
CAMRY	ACV, MCV36	09/02 - ON	BLOCK	PAD - PAD	VA-48952		new	R134a
CELICA	SOME		REV. - EXT.	MIOR - MIOR	VA-33178	VA-13464	381	No.5 MIOR INLET
CELICA	SOME		REV. - INT.	MIOR - MIOR	VA-25525	VA-13452	380	No.5 MIOR INLET
CELICA	RA60, RA63, SA65		STD. - INT.	MIOR - MIOR	VA-25447	VA-13447	380	No.5 MIOR INLET
CELICA	ST162	1985 - ON	STD. - INT.	MIOR - MIOR	VA-25510	VA-13448	380	No.5 MIOR INLET
CELICA	ST184, ST185	1989 - 03/94	BLOCK	PAD - PAD	VA-49824	VA-13824	384	
CELICA	ST204, ST205	03/94 - 11/99	BLOCK	PAD - PAD	VA-48865	VA-13865	384	
CELICA	ZZT231R	11/99 - ON	BLOCK	PAD - PAD	VA-48952		new	
COROLLA	AE71, AE80, AE82, AE86		STD. - INT.	MIOR - MIOR	VA-25447	VA-13447	380	R12 No.5 MIOR INLET
COROLLA AE90,	AE92, AE93, AE94, AE95	TO - 07/93	STD. - INT.	MIOR - MIOR	VA-25510	VA-13448	380	R12 No.5 MIOR INLET
COROLLA	AE92, AE94, AE95, AE96	08/93 - 05/94	STD. - INT.	MIOR - MIOR	VA-31214	VA-13449	380	R134a METRIC M16-M22
COROLLA	AE101, AE102	1994 - 07/99	BLOCK	PAD - PAD	VA-48865	VA-13865	384	R134a
COROLLA	AE112R	11/99 - 11/01	BLOCK	PAD - PAD	VA-48865	VA-13865	384	R134a
COROLLA	KE70, TE72, T18		STD. - INT.	MIOR - MIOR	VA-25447	VA-13447	380	R12 No.5 MIOR INLET
COROLLA	ZZE122R	10/01 - ON	BLOCK	PAD - PAD	VA-48952		new	R134a
CORONA	RT142, ST141, XT130		STD. - INT.	MIOR - MIOR	VA-25447	VA-13447	380	R12 No.5 MIOR INLET
CORONA	(SOME)		REV. - EXT.	MIOR - MIOR	VA-35462	VA-13462	382	METRIC M16- #8
CRESSIDA	MX62, MX73,	12/80 - ON	REV. - EXT.	MIOR - MIOR	VA-33122		381	R12 No.5 MIOR INLET
CRESSIDA	MX83	10/88 - 01/93	REV. - EXT.	MIOR - MIOR	VA-33169	VA-38050	381	No.5 MIOR INLET
CRESSIDA		LATE -	REV. - EXT.	MIOR - MIOR	VA-33178	VA-13464	381	No.5 MIOR INLET
CROWN	MS112, MS123		REV. - EXT.	MIOR - MIOR	VA-33122		381	R12 No.5 MIOR INLET
DYNA	BU20, BU91	1988 - 1994	STD. - INT.	MIOR - MIOR	VA-25447	VA-13447	380	R12 No.5 MIOR INLET
DYNA	BU100, BU110, BU142	07/95 - ON	BLOCK	PAD - PAD	VA-48865	VA-13865	384	R134a
DYNA	WU90, YU62	1987 - ON	STD. - INT.	MIOR - MIOR	VA-25447	VA-13447	380	R12 No.5 MIOR INLET
DYNA 100	LH80, YH81	1991 - 1992	STD. - INT.	MIOR - MIOR	VA-25447	VA-13447	380	R12 No.5 MIOR INLET
DYNA 100	YY100	10/95 - ON	BLOCK	PAD - PAD	VA-48865	VA-13865	384	R134a
DYNA 150	LY60	1988 - 1992	STD. - INT.	MIOR - MIOR	VA-25447	VA-13447	380	R12 No.5 MIOR INLET
DYNA 150	LY211	05/95 - ON	BLOCK	PAD - PAD	VA-48865	VA-13865	384	R134a
HIACE	LH50, LH51, LH61, LH70, LH71		STD. - INT.	MIOR - MIOR	VA-25447	VA-13447	380	R12 No.5 MIOR INLET
HIACE / COMMUTER	LH70, 71, 125 (REAR UNIT)		STD. - EXT.	MIOR - MIOR	VA-33105		381	R12 No.5 MIOR INLET
HIACE	LH103, LH113, LH125	TO - 07/93	BLOCK	PAD - PAD	VA-49824	VA-13824	384	R12
HIACE	LH103, LH113, LH125	08/93 - ON	BLOCK	PAD - PAD	VA-48865	VA-13865	384	R134a
HIACE	RZH (REAR UNIT)	TO - 07/93	STD. - EXT.	MIOR - MIOR	VA-33105		381	R12 No.5 MIOR INLET
HIACE	RZH (FRONT)	TO - 07/93	BLOCK	PAD - PAD	VA-49824	VA-13824	384	R12
HIACE	RZH103, RZH113, RZH125	08/93 - ON	BLOCK	PAD - PAD	VA-48865	VA-13865	384	R134a
HIACE	YH (FRONT ONLY)		STD. - INT.	MIOR - MIOR	VA-25447	VA-13447	380	R12 No.5 MIOR INLET
HIACE	YH (REAR UNIT)		STD. - EXT.	MIOR - MIOR	VA-33105		381	R12 No.5 MIOR INLET
HILUX	LN55, LN56, LN57, LN65		STD. - INT.	MIOR - MIOR	VA-25447	VA-13447	380	R12 No.5 MIOR INLET
HILUX	LN	08/90 - 11/93	STD. - INT.	MIOR - MIOR	VA-25510	VA-13448	380	R12 No.5 MIOR INLET
HILUX	LN (R134a)	12/93 - 07/97	STD. - INT.	MIOR - MIOR	VA-31214	VA-13449	380	R134a METRIC M16-M22
HILUX	RN	08/91 - 11/93	STD. - INT.	MIOR - MIOR	VA-25510	VA-13448	380	R12 No.5 MIOR INLET
HILUX	RN	12/93 - 07/97	STD. - INT.	MIOR - MIOR	VA-31214	VA-13449	380	R134a METRIC M16-M22
HILUX	YN55, 57, 65, 67	07/91 - 07/94	STD. - INT.	MIOR - MIOR	VA-25447	VA-13447	380	R12 No.5 MIOR INLET
HILUX	YN85	TO - 07/97	STD. - INT.	MIOR - MIOR	VA-25510	VA-13448	380	R134a No.5 MIOR INLET
HILUX 4-Runner	LN / RN / VZN 130	12/90 - 07/93	BLOCK	PAD - PAD	VA-49824	VA-13824	384	R12
HILUX 4-Runner	LN / RN / VZN 130	08/93 - 05/96	BLOCK	PAD - PAD	VA-48865	VA-13865	384	R12
HILUX 4-Runner	YN60, YN63		STD. - INT.	MIOR - MIOR	VA-25447	VA-13447	380	R12 No.5 MIOR INLET
HILUX 4-Runner	YN130	12/90 - 07/91	BLOCK	PAD - PAD	VA-49824	VA-13824	384	R12
LANDCRUISER	BJ70		STD. - INT.	MIOR - MIOR	VA-25447	VA-13447	380	R12 No.5 MIOR INLET
LANDCRUISER	FJ40, FJ45		STD. - INT.	MF - MF	VA-13410		379	R12
LANDCRUISER	FJ60, FJ62		STD. - INT.	MIOR - MIOR	VA-25447	VA-13447	380	R12 No.5 MIOR INLET
LANDCRUISER	FJ70, FJ73, FJ75	TO - 02/87	STD. - INT.	MIOR - MIOR	VA-25447	VA-13447	380	R12 No.5 MIOR INLET
LANDCRUISER	FJ80	01/90 - 07/92	BLOCK	PAD - PAD	VA-49824	VA-13824	384	R12
LANDCRUISER	FZJ75	08/92 - 04/93	STD. - INT.	MIOR - MIOR	VA-25447	VA-13447	380	R12 No.5 MIOR INLET
LANDCRUISER	FZJ80	08/92 - 04/93	BLOCK	PAD - PAD	VA-49824	VA-13824	384	R12
LANDCRUISER	FZJ80	05/93 - 12/97	BLOCK	PAD - PAD	VA-48865	VA-13865	384	R134a
LANDCRUISER	FZJ105; 1FZ - FE	01/98 - ON	BLOCK	PAD - PAD	VA-48977	VA-60050	384	R134a
LANDCRUISER	HDJ80	01/90 - 04/93	BLOCK	PAD - PAD	VA-49824	VA-13824	384	R12 047500-1730
LANDCRUISER	HDJ80	05/93 - 12/97	BLOCK	PAD - PAD	VA-48865	VA-13865	384	R134a
LANDCRUISER	HDJ80	10/00 - ON	BLOCK	PAD - PAD	VA-48977	VA-60050	384	R134a
LANDCRUISER	HDJ100	10/00 - ON	BLOCK	PAD - PAD	VA-48977	VA-60050	384	R134a
LANDCRUISER	HJ60, HJ61		STD. - INT.	MIOR - MIOR	VA-25447	VA-13447	380	R12 No.5 MIOR INLET
LANDCRUISER	HJ70, HJ73, HJ75		STD. - INT.	MIOR - MIOR	VA-25447	VA-13447	380	R12 No.5 MIOR INLET
LANDCRUISER	HZJ75	TO - 1993	STD. - INT.	MIOR - MIOR	VA-25447	VA-13447	380	R12 No.5 MIOR INLET
LANDCRUISER	HZJ75, HZJ78, HZJ79	1993 - ON	STD. - INT.	MIOR - MIOR	VA-31214	VA-13449	380	R134a METRIC M16-M22

Note : To ensure compatability and retain system performance, check the specifications on pages 367-368 against OEM specifications.

TX Valve Application Guide

Application Guide by Vehicle Make / Model

Vehicle	Model / Code	Year	Type	Fittings	Part No.	S/Sedes	Page	Other / OEM Reference
TOYOTA . . . cont'd.								
LANDCRUISER	HZJ80	01/90 - 04/93	BLOCK	PAD - PAD	VA-49824	VA-13824	384	R12
LANDCRUISER	HZJ80	05/93 - 12/97	BLOCK	PAD - PAD	VA-48865	VA-13865	384	R134a
LANDCRUISER	HZJ105 1HZ	01/98 - ON	BLOCK	PAD - PAD	VA-48977	VA-60050	384	R134a
LANDCRUISER	UZJ100	03/98 - ON	BLOCK	PAD - PAD	VA-48977	VA-60050	384	R134a
LEXCEN	SOME	1989 - 08/93	Orifice Tube		VA-10250		365	colour code: blue
LEXUS	ES300	03/92 - 07/93	BLOCK	PAD - PAD	VA-49824	VA-13824	384	R12
LEXUS	ES300	08/93 - ON	BLOCK	PAD - PAD	VA-48865	VA-13865	384	R134a
LEXUS	ES300	07/01 - ON	BLOCK	PAD - PAD	VA-48952		new	
LEXUS	IS200	03/99 - ON	BLOCK	PAD - PAD	VA-48952		new	
LEXUS	LS400	11/94 - 10/00	REV. - EXT.	COR - COR	VA-37653		383	Pad Equalizer Capillary
LEXUS	LX470	01/98 - 08/98	BLOCK	PAD - PAD	VA-48952		new	
LEXUS	LX470	09/98 - ON	BLOCK	PAD - PAD	VA-48977	VA-60050	384	
LITE-ACE	ALL	TO - 03/92	STD. - INT.	MIOR - MIOR	VA-25447	VA-13447	380	R12 No.5 MIOR INLET
LITE-ACE	REAR UNIT	TO - 03/92	STD. - INT.	MIOR - MIOR	VA-25447	VA-13447	380	R12 No.5 MIOR INLET
MR2	AW11		STD. - INT.	MIOR - MIOR	VA-25447	VA-13447	380	R12 No.5 MIOR INLET
MR2	SW20	12/91 - 08/93	BLOCK	PAD - PAD	VA-49824	VA-13824	384	R12
MR2	SW20 3S-GE	09/93 - ON	BLOCK	PAD - PAD	VA-48865	VA-13865	384	R134a
PASEO	EL44 (SOME)	04/91 - 07/93	STD. - INT.	MIOR - MIOR	VA-25447	VA-13447	380	R12 No.5 MIOR INLET
PASEO	EL44 (SOME)	08/93 - 12/95	BLOCK	PAD - PAD	VA-49824	VA-13824	384	R12
PASEO	EL54	1996 - ON	BLOCK	PAD - PAD	VA-48865	VA-13865	384	R134a
PRADO	KZJ95, RZJ95, VZJ95	05/96 - ON	BLOCK	PAD - PAD	VA-48865	VA-13865	384	R134a
RAV - 4	SXA11	03/94 - 05/00	BLOCK	PAD - PAD	VA-48865	VA-13865	384	R134a
STARLET		1996 - 10/00	BLOCK	PAD - PAD	VA-48865	VA-13865	384	R134a
SUPRA	(SOME)		REV. - INT.	MIOR - MIOR	VA-25525	VA-13452	380	No.5 MIOR INLET
SUPRA	MA61		STD. - EXT.	MIOR - MIOR	VA-33138		381	R12 No.5 MIOR INLET
SUPRA	MA70		STD. - INT.	MIOR - MIOR	VA-25447	VA-13447	380	R12 No.5 MIOR INLET
TARAGO	CR21		STD. - INT.	MIOR - MIOR	VA-25447	VA-13447	380	R12 No.5 MIOR INLET
TARAGO	CR21 (REAR UNIT)		STD. - INT.	MIOR - MIOR	VA-25447	VA-13447	380	R12 No.5 MIOR INLET
TARAGO	TCR	08/91 - 07/93	BLOCK	PAD - PAD	VA-49824	VA-13824	384	R12
TARAGO	TCR (REAR UNIT)		BLOCK	PAD - PAD	VA-49824	VA-13824	384	R12
TARAGO	TCR	08/93 - ON	BLOCK	PAD - PAD	VA-48865	VA-13865	384	R134a
TARAGO	YR20, YR21, YR22, YR31		STD. - INT.	MIOR - MIOR	VA-25447	VA-13447	380	R12 No.5 MIOR INLET
TARAGO	YR20, 21, 22, 31 (REAR)		STD. - INT.	MIOR - MIOR	VA-25447	VA-13447	380	R12 No.5 MIOR INLET
TERCEL	AL25		STD. - INT.	MIOR - MIOR	VA-25447	VA-13447	380	R12 No.5 MIOR INLET
TOWN-ACE			STD. - INT.	MIOR - MIOR	VA-25447	VA-13447	380	R12 No.5 MIOR INLET
VERSATILE								
TRACTORS	SOME		BLOCK	FOR - FOR	VA-46875	VA-13575	383	
VOLKSWAGEN								
GOLF		1984 - ON	BLOCK	FOR - FOR	VA-46282		383	R12
GOLF		01/94 - ON	BLOCK	PAD - PAD	VA-52947	VA-13960	384	R134a
JETTA		1984 - ON	BLOCK	FOR - FOR	VA-46282		383	R12
PASSAT		1988 - ON	BLOCK	FOR - FOR	VA-46282		383	R12
PASSAT		1992 - ON	BLOCK	PAD - PAD	VA-52947	VA-13960	384	
PASSAT		03/98 - ON	Orifice Tube		VA-10244		365	colour code: red
TRANSPORTER	T4 NIPPON DENSO	02/97 - ON	BLOCK	PAD - PAD	VA-48865	VA-13865	384	R134a
VENTO		01/94 - ON	BLOCK	PAD - PAD	VA-52947	VA-13960	384	
VOLVO								
SOME			STD. - EXT.	MIOR - MIOR	VA-34691	VA-13488	382	OE: 1258659
240 SERIES			STD. - EXT.	MIOR - MIOR	VA-34464	VA-13470	381	OE: 4780857
740			Orifice Tube		VA-10270		365	colour code: white
FL	TRUCK		BLOCK	FOR - FOR	VA-46924	VA-13567	384	
WHITE								
SOME			BLOCK	FOR - FOR	VA-46560	VA-13730	383	

Note : To ensure compatability and retain system performance, check the specifications on pages 367-368 against OEM specifications.

Thermostatic Expansion Valves

90 deg. TX VALVES - MALE FLARE

Internally Equalized

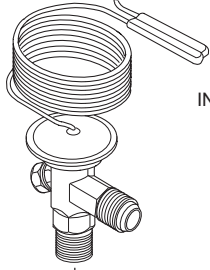

VA-13405

INTERNALLY EQUALIZED

6 MF INLET
8 MF OUTLET

CAPACITY VARIES WITH ORIFICE SIZE:

MIOR INLET BECOMES MF WHEN ORIFICE IS INSTALLED
VA-10130 ORIFICE GIVES 1.0 ton
VA-10140 ORIFICE GIVES 1.5 tons
VA-10150 ORIFICE GIVES 2.0 tons
VA-10160 ORIFICE GIVES 3.0 tons

SUPERHEAT: 3.33 °C
SENSING CAPILLARY: 1500 mm; BULB

- GENERAL USE

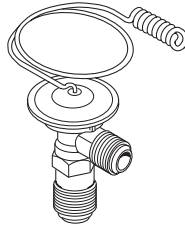

VA-13410

INTERNALLY EQUALIZED

6 MF INLET
8 MF OUTLET

CAPACITY: 1.0 ton.
SUPERHEAT: 3.0 °C
SENSING CAPILLARY: 200mm; COIL

- MOST JAPANESE UNDERDASH UNITS
- TOYOTA L/CRUISER FJ40, FJ45
- GENERAL USE

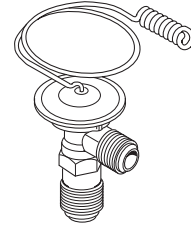

VA-13415

INTERNALLY EQUALIZED

6 MF INLET
8 MF OUTLET

CAPACITY: 1.5 tons.
SUPERHEAT: 4.44 °C
SENSING CAPILLARY: 305mm; COIL

- ARA & FRIGIKING: ROOFTOP MODELS
- INTERNATIONAL: FLEETSTAR, TRANSTAR
- JOHN DEERE: TRACTORS WITH FLARE
- KYSOR: EARLY MODELS WITH FLARE
- MARK IV: MOST MODELS
- MAZDA: 626 1979-1981 WITH FLARE
- MITSUBISHI: CORDIA; PAJERO NA - NF
- NISSAN: PATROL TO JAN. 1984
- PORSCHE: 911; 912; 914; 924

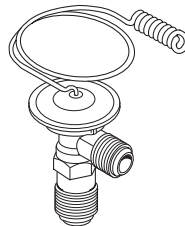

VA-13420

INTERNALLY EQUALIZED

6 MF INLET
8 MF OUTLET

CAPACITY: 2.0 tons.
SUPERHEAT: 2.78 °C
SENSING CAPILLARY: 305mm; COIL

- CASE TRACTORS (SOME)
- SIGMA: ROOFTOP UNITS (SOME)

90 deg. TX VALVES - MALE FLARE

Externally Equalized

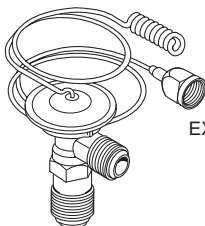

VA-13434

EXTERNALLY EQUALIZED

6 MF INLET
8 MF OUTLET

CAPACITY: 1.5 ton.
SUPERHEAT: 4.44 °C
SENSING CAPILLARY: 483mm; COIL
EQUALIZER CAPILLARY: 419mm; 1/4" FF

- AUDI: FOX, 100LS (replaces #ZAW-411-057)
- BMW: 3 SERIES ALL TO 1983
- JOHN DEERE: SOME WITH FLARE
- KENWORTH: W900 WITH RED DOT

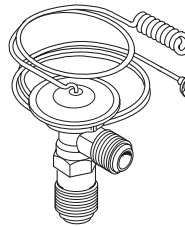

VA-13438

EXTERNALLY EQUALIZED

6 MF INLET
8 MF OUTLET

CAPACITY: 2.0 ton.
SUPERHEAT: 4.44 °C
SENSING CAPILLARY: 465mm; COIL
EQUALIZER CAPILLARY: 700mm; 1/4" FF

- CASE: 912, 2290
- CATERPILLAR: SOME EARLY MODELS (REPLACES OE # 1P 6526)
- INTERNATIONAL: TRANSTAR, PAYSTAR (REPLACES OE # 63398-C1)

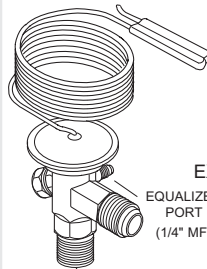

VA-13445

EXTERNALLY EQUALIZED

EQUALIZER PORT (1/4" MF)
6 MF INLET
8 MF OUTLET

CAPACITY VARIES WITH ORIFICE SIZE:
VA-10130 ORIFICE GIVES 1.0 ton
VA-10140 ORIFICE GIVES 1.5 tons
VA-10150 ORIFICE GIVES 2.0 tons
VA-10160 ORIFICE GIVES 3.0 tons

- SUPERHEAT: 3.33 °C
SENSING CAPILLARY: 1500mm; BULB
- SIGMA ROOFTOPS (**CHECK CAPACITY**)

Thermostatic Expansion Valves

90 deg. TX VALVES - O-RING (MIOR)

Internally Equalized

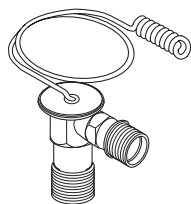

VA-25447

Replaces VA-13447
INTERNALLY EQUALIZED
COMPACT ASSEMBLY

5 MIOR INLET
8 MIOR OUTLET

CAPACITY: 1.0 ton.
SUPERHEAT: 3.9 °C
SENSING CAPILLARY: 265mm; COIL

- FORD: LASER KA - KF TO 1990
TELSTAR AR-AS SOME
- MAZDA: 626 1983 - 85 SOME
- NIPPON DENSO (COMMON)

SEE ALSO VA-34123 TELSTAR AND 626 WITH EXTERNALLY EQUALIZED VALVES

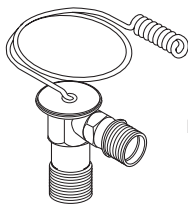

VA-25510

Replaces VA-13448
INTERNALLY EQUALIZED
COMPACT ASSEMBLY

5 MIOR INLET
8 MIOR OUTLET

CAPACITY: 1.5 tons.
SUPERHEAT: 3.9 °C
SENSING CAPILLARY: 200mm; COIL

- DAIHATSU SOME
- G.M: APOLLO
- MITSUBISHI: MAGNA TM - TP WITH # 5
- NIPPON DENSO (COMMON)
- TOYOTA: CAMRY SV11; SV20; SV21

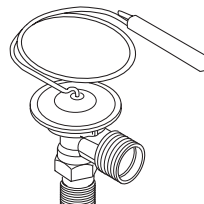

VA-25525

Replaces VA-13452
INTERNALLY EQUALIZED
REVERSE ASSEMBLY

5 MIOR INLET
8 MIOR OUTLET

CAPACITY: 1.5 tons.
SUPERHEAT: 4.44 °C
SENSING CAPILLARY 360mm; BULB

- TOYOTA: CELICA (SOME)
SUPRA (SOME)
- UNIVERSAL: GENERAL USE

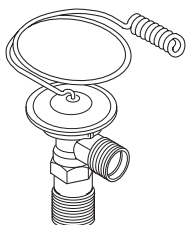

VA-27140

INTERNALLY EQUALIZED

6 MIOR INLET
8 MIOR OUTLET

CAPACITY: 1.0 ton.
SENSING CAPILLARY: 230mm COIL

- DAIHATSU: CHARADE 1982 on
- **REPLACES NIPPON DENSO**
OE:047500-0500

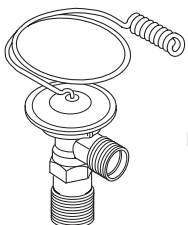

VA-27462

Replaces VA-13450

INTERNALLY EQUALIZED

6 MIOR INLET
8 MIOR OUTLET

CAPACITY: 1.5 tons.
SUPERHEAT: 2.78 °C
SENSING CAPILLARY: 203mm, COIL

- ARA: ROOFTOP UNITS WITH O-RING
(REPLACES OE # 1296340)
- INTERNATIONAL: ACCO
- LANDROVER: DISCOVERY 1991 on
DEFENDER

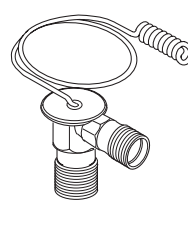

VA-27494

Replaces VA-13457

INTERNALLY EQUALIZED

COMPACT ASSEMBLY
6 MIOR INLET
8 MIOR OUTLET

CAPACITY: 1.0 ton.
SUPERHEAT: 3.0 °C
SENSING CAPILLARY: 200mm; COIL

- COOLTEMP UNITS (MOST)
- FORD: FESTIVA WA
- GM: ASTRA LD
- MITSUBISHI: EXPRESS, STARWAGON

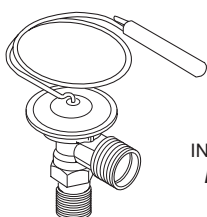

VA-27668

Replaces VA-13453
INTERNALLY EQUALIZED
REVERSE ASSEMBLY

6 MIOR INLET
8 MIOR OUTLET

CAPACITY: 2.0 tons.
SUPERHEAT: 4.44 °C
SENSING CAPILLARY: 305mm; BULB

- HONDA: ACCORD 1985-1989
CIVIC SOME
PRELUDE SOME
- UNIVERSAL - GENERAL USE

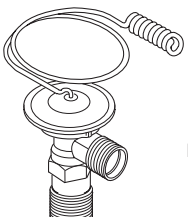

VA-27687

Replaces VA-13455

INTERNALLY EQUALIZED

6 MIOR INLET
8 MIOR OUTLET

CAPACITY: 2.0 tons.
SUPERHEAT: 2.78 °C
SENSING CAPILLARY: 305mm; COIL

- CATERPILLAR 320 EXCAVATOR
- RANGEROVER
- UNIVERSAL - GENERAL USE

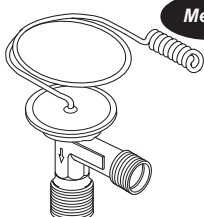

Metric

VA-30940

Replaces VA-13446

INTERNALLY EQUALIZED
COMPACT ASSEMBLY

METRIC M16 INLET
METRIC M20 OUTLET

CAPACITY: 1.0 ton.
SUPERHEAT: 4.4 °C
SENSING CAPILLARY 210mm; COIL

- FORD: COURIER
- ISEKI: TRACTOR
- MAZDA: B SERIES
- SUBARU: IMPREZA, FORESTER



Metric
Captive O-Ring

VA-30952

INTERNALLY EQUALIZED
REVERSE ASSEMBLY
METRIC M16 INLET
METRIC M22 OUTLET

CAPACITY: 1.0 ton.
SENSING CAPILLARY: 250mm; BULB

- DAIHATSU: TERIOS

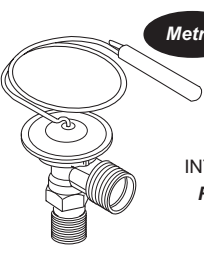

Metric

VA-31074

INTERNALLY EQUALIZED
REVERSE ASSEMBLY
METRIC M16 INLET
METRIC M20 OUTLET

CAPACITY: 1.5 tons.
SENSING CAPILLARY 280mm; BULB

- NISSAN: NAVARA D22 02/97 on
PULSAR N15

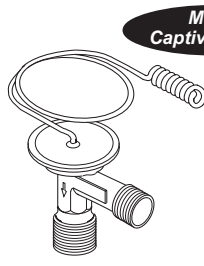

Metric
Captive O-Ring

VA-31214

Replaces VA-13449
INTERNALLY EQUALIZED
COMPACT ASSEMBLY
METRIC M16 INLET
METRIC M22 OUTLET

CAPACITY: 1.5 tons.
SENSING CAPILLARY: 220mm; COIL

- SUZUKI: VITARA: X90
- TOYOTA: COROLLA 08/93 - 5/94
HILUX 12/93 - 07/97
L/CRUISER HZJ75, 78, 79
1993 on

Thermostatic Expansion Valves

90 deg. TX VALVES - O-RING (MIOR)

Externally Equalized

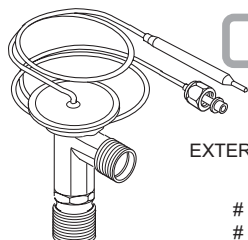

VA-33105

EXTERNALLY EQUALIZED

5 MIOR INLET
8 MIOR OUTLETCAPACITY: 1.0 ton.
SENSING CAPILLARY: 230mm; BULB
EQUALIZER CAPILLARY: 200mm; 1/4" FOR

- TOYOTA: HIACE & COMMUTER REAR UNITS

REPLACES NIPPON DENSO 047500-0620

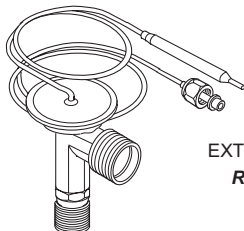

VA-33122

EXTERNALLY EQUALIZED

REVERSE ASSEMBLY

5 MIOR INLET
8 MIOR OUTLETCAPACITY: 1.0 ton.
SENSING CAPILLARY: 230mm; BULB
EQUALIZER CAPILLARY: 550mm; 1/4" FOR

- TOYOTA: CRESSIDA MX62, MX73
CROWN MS112, MS123

REPLACES NIPPON DENSO 047500-1530

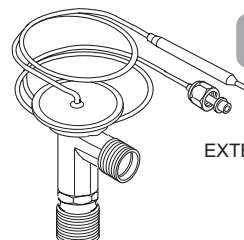

VA-33138

EXTERNALLY EQUALIZED

5 MIOR INLET
8 MIOR OUTLETCAPACITY: 1.0 ton.
SENSING CAPILLARY: 230mm; BULB
EQUALIZER CAPILLARY: 650mm; 1/4" FOR

- TOYOTA SUPRA MA61
- MAZDA 929

REPLACES NIPPON DENSO 047500-0490

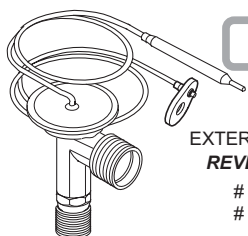

VA-33169

EXTERNALLY EQUALIZED

REVERSE ASSEMBLY

5 MIOR INLET
8 MIOR OUTLETSENSING CAPILLARY: 230mm; BULB
EQUALIZER CAPILLARY: 620mm; PAD

- HONDA ODYSSEY 2000 on
- NIPPON DENSO: OE: 047500-1561
- TOYOTA CRESSIDA MX83

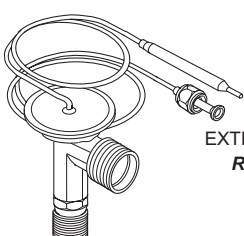

VA-33174

EXTERNALLY EQUALIZED

REVERSE ASSEMBLY

5 MIOR INLET
8 MIOR OUTLETSENSING CAPILLARY: 220mm; BULB
EQUALIZER CAPILLARY: 310mm; 1/4" FF
(Female Flare)

- FORD LASER KF, KH
- MAZDA 323, ASTINA 1990-94

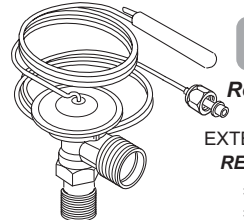

VA-33178

Replaces VA-13464

EXTERNALLY EQUALIZED

REVERSE ASSEMBLY

5 MIOR INLET
8 MIOR OUTLETCAPACITY: 1.5 tons.
SUPERHEAT: 4.44 °C
SENSING CAPILLARY: 305mm; BULB
EQUALIZER CAPILLARY: 838mm; 1/4" FOR

- MITSUBISHI: LANCER CA - CC
NIMBUS UF
PAJERO SOME
- TOYOTA: CELICA SOME
CRESSIDA LATE
SUPRA SOME

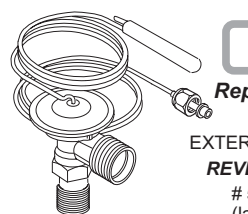

VA-33196

Replaces VA-13465

EXTERNALLY EQUALIZED

REVERSE ASSEMBLY

5 MIOR INLET
(large I.D. - 8.5mm)
8 MIOR OUTLETCAPACITY: 1.5 ton.
SENSING CAPILLARY: 195mm; BULB
EQUALIZER CAPILLARY: 215mm; 1/4" FOR

- MITSUBISHI: MAGNA TE, TF, TH, TJ
TRITON MK

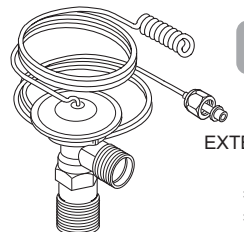

VA-34123

EXTERNALLY EQUALIZED

6 MIOR INLET
8 MIOR OUTLETCAPACITY: 1.0 ton. SUPERHEAT: 4.44 °C
SENSING CAPILLARY: 203mm; COIL
EQUALIZER CAPILLARY: 247mm; 1/4" FOR

- FORD: AR - AS 1983-85 (SOME)
- MAZDA: 626 1983-85 (SOME)

SEE ALSO VA-25447 TELSTAR AND 626 WITH INTERNALLY EQUALIZED VALVES

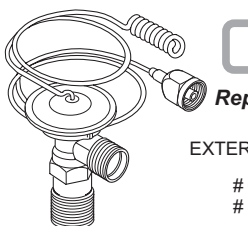

VA-34464

Replaces VA-13470

EXTERNALLY EQUALIZED

6 MIOR INLET
8 MIOR OUTLETCAPACITY: 1.5 tons.
SUPERHEAT: 4.44 °C
SENSING CAPILLARY: 305mm; COIL
EQUALIZER CAPILLARY: 330mm; 1/4" FOR

- CATERPILLAR: REPLACES OE # 2G 0401
- FORD: COURIER
- GM: COMMODORE VL
- JEEP: GRAND CHEROKEE 03/96 on
- INTER: T-LINE; S-LINE (EXC. DT466); 9670
- HYUNDAI: EXCEL 1987 - 1990
- KENWORTH: K100; BERGSTROM (SOME)
- MACK: (SOME MODELS WITH KYSOR)
- SAAB: 900 (SOME)
- VOLVO: (SOME) OE - 4780857

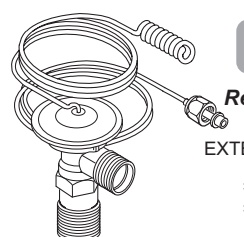

VA-34489

Replaces VA-13460

EXTERNALLY EQUALIZED

6 MIOR INLET
8 MIOR OUTLETCAPACITY: 1.5 tons.
SUPERHEAT: 2.78 °C
SENSING CAPILLARY: 483mm; COIL
EQUALIZER CAPILLARY: 420mm; 1/4" FOR

- CHRYSLER: VALIANT
- HONDA: PRELUDE
- UNIVERSAL: GENERAL USE

Thermostatic Expansion Valves

90 deg. TX VALVES - O-RING (MIOR)

Externally Equalized

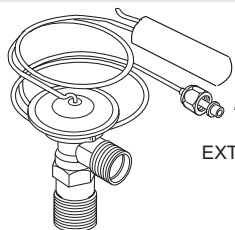

VA-34637

Replaces VA-13480

EXTERNALLY EQUALIZED
6 MIOR INLET
8 MIOR OUTLET

CAPACITY: 2.0 tons. SUPERHEAT: 2.78 °C
SENSING CAPILLARY: 203mm; BULB
EQUALIZER CAPILLARY: 248mm; 1/4" FOR

- ALLIS CHALMERS: 7040, 7060, 7080, 7580 & 8550 (REPLACES OE #70268470-5)
- CASE: SOME
- JOHN DEERE: SOME WITH O-RING (REPLACES OE # AR58482)
- MASSEY: MOST WITH STD. O-RING

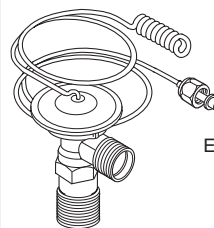

VA-34662

Replaces VA-13484

EXTERNALLY EQUALIZED
6 MIOR INLET
8 MIOR OUTLET

CAPACITY: 2.0 tons. SUPERHEAT: 2.78 °C
SENSING CAPILLARY: 203mm; COIL
EQUALIZER CAPILLARY: 248mm; 1/4" FOR

- JAGUAR: SERIES II, XJ6, XJS
- SAAB: 9000 to 1991
- ROLLS ROYCE: (MOST) (REPLACES OE # 6551445)

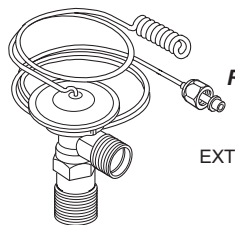

VA-34691

Replaces VA-13488

EXTERNALLY EQUALIZED
6 MIOR INLET
8 MIOR OUTLET

CAPACITY: 2.0 tons.
SUPERHEAT: 4.44 °C.
SENSING CAPILLARY: 305mm; COIL
EQUALIZER CAPILLARY: 419mm; 1/4" FOR

- BERGSTROM: SOME
- CASE: SOME
- GM: COMMODORE VB, VC, VK
- GM: CAMIRA
- INTERNATIONAL: (REPLACES OE 118305-C3)
- KYSOR: KA200; KA300 (REPLACES OE # 404073)
- VOLVO: (SOME) (REPLACES OE #1258659)

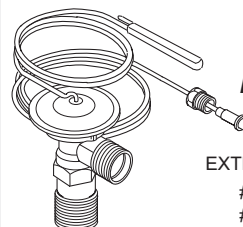

VA-34867

Replaces VA-13496

EXTERNALLY EQUALIZED
6 MIOR INLET
8 MIOR OUTLET

CAPACITY: 2.0 tons.
SUPERHEAT: 5.83 °C
SENSING CAPILLARY: 838mm; BULB
EQUALIZER CAPILLARY: 787mm; 1/4" MOR

- GM: COMMODORE VB WITH HARRISON HOLDEN / STATESMAN HQ-HZ
- KYSOR: SOME
- ROLLS ROYCE: WITH POAST VALVE

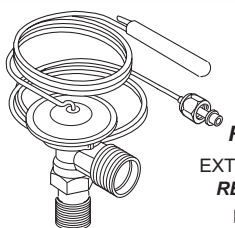

VA-35462

Replaces VA-13462

EXTERNALLY EQUALIZED
REVERSE ASSEMBLY
M16 MIOR INLET
8 MIOR OUTLET

CAPACITY: 1.5 tons.
SUPERHEAT: 4.44 °C
SENSING CAPILLARY: 305mm; BULB
EQUALIZER CAPILLARY: 838mm; 1/4" FOR

- UNIVERSAL: GENERAL USE
- NISSAN: MAXIMA J30 PINTARA
- TOYOTA: CORONA

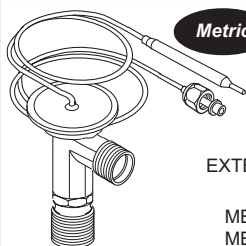

Metric

VA-36324

EXTERNALLY EQUALIZED

METRIC M16 INLET
METRIC M20 OUTLET

CAPACITY: 1.0 ton.
SENSING CAPILLARY: 235mm; BULB
EQUALIZER CAPILLARY: 310mm; M12 FOR

- NISSAN PULSAR N14, N15 (SOME)
- UNIVERSAL: GENERAL USE

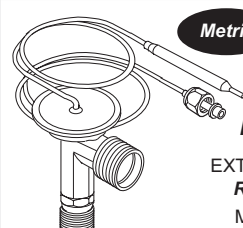

Metric

VA-36356

Replaces VA-13456

EXTERNALLY EQUALIZED
REVERSE ASSEMBLY
METRIC M16 INLET
METRIC M20 OUTLET

CAPACITY: 1.0 ton.
SENSING CAPILLARY: 190mm; BULB
EQUALIZER CAPILLARY: 305mm; FOR

- HYUNDAI: EXCEL 1995 on
- KIA: SPORTAGE 1997 on
- NISSAN: PULSAR N14 (SOME)

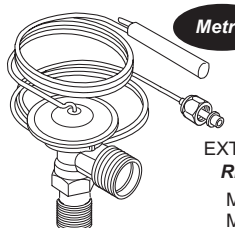

Metric

VA-36461

EXTERNALLY EQUALIZED
REVERSE ASSEMBLY
METRIC M16 INLET
METRIC M20 OUTLET

CAPACITY: 1.5 tons.
SENSING CAPILLARY: 215mm; BULB
EQUALIZER CAPILLARY: 215mm; FOR

- ISUZU: NPR, NPS
- MITSUBISHI: EXPRESS WA STARWAGON WA

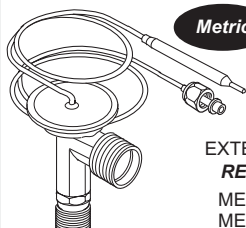

Metric

VA-36468

EXTERNALLY EQUALIZED
REVERSE ASSEMBLY
METRIC M16 INLET
METRIC M20 OUTLET

CAPACITY: 1.0 ton.
SENSING CAPILLARY: 285mm; BULB
EQUALIZER CAPILLARY: 230mm; M12 FOR

- FORD: LASER KJ, KL
- MAZDA: 323, ASTINA 1994 on

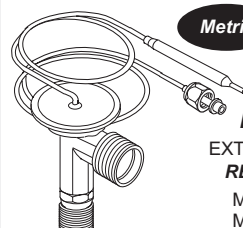

Metric

VA-36472

Replaces VA-13472
EXTERNALLY EQUALIZED
REVERSE ASSEMBLY
METRIC M16 INLET
METRIC M20 OUTLET

CAPACITY: 1.5 tons.
SUPERHEAT: 4.44 °C
SENSING CAPILLARY: 305mm; BULB
EQUALIZER CAPILLARY: 324mm; M12 FOR

- GENERAL USE
- DAEWOO: MATIZ
- FORD: MAVERICK
- MITSUBISHI: LANCER, MIRAGE
- NISSAN: PATROL

Thermostatic Expansion Valves

O-RING (MIOR) 90 deg. TX VALVES

Externally Equalized

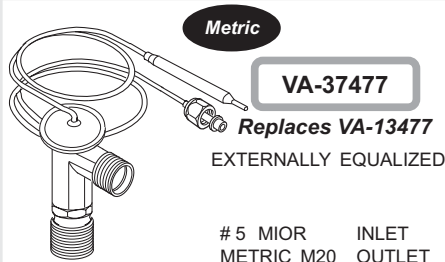

SENSING CAPILLARY: 280mm; BULB
EQUALIZER CAPILLARY: 240mm; M12 FOR

- FORD: TELSTAR AT - AV
- MAZDA: 626 GD 1990 on

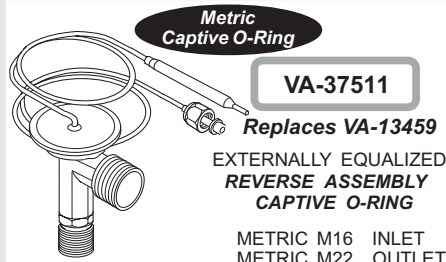

CAPACITY: 1.0 ton.
SENSING CAPILLARY: 380mm; BULB
EQUALIZER CAPILLARY: 340mm; M12 FOR

- NIPPON DENSO SOME LATE SYSTEMS

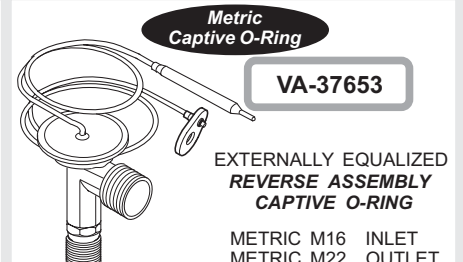

CAPACITY: 1.5 ton.
SENSING CAPILLARY: 220mm; BULB
EQUALIZER CAPILLARY: 716mm; PAD

- TOYOTA LEXUS LS400 11/94 - 10/00

BLOCK VALVES - O-RING (Threaded)

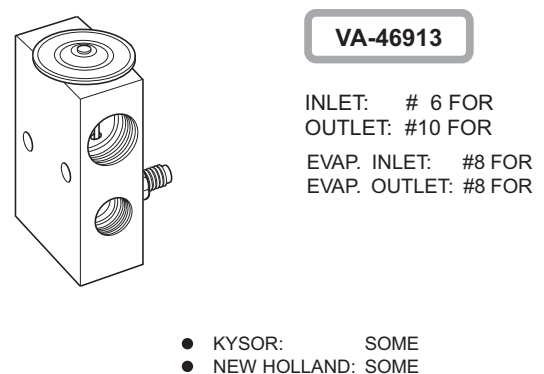
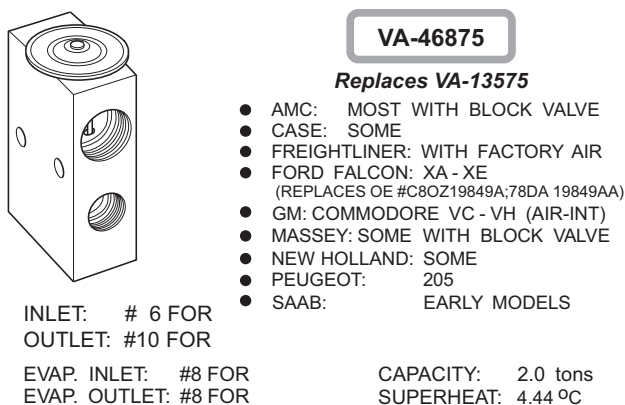
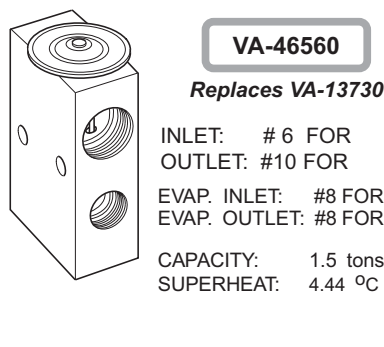
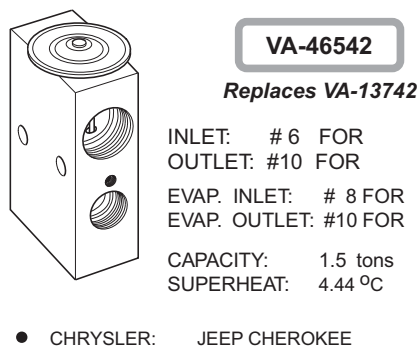
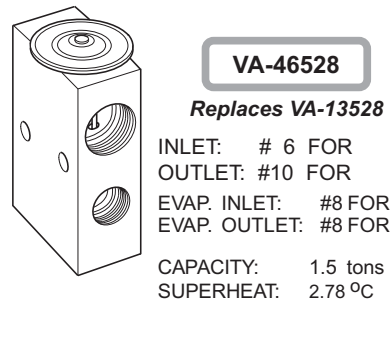
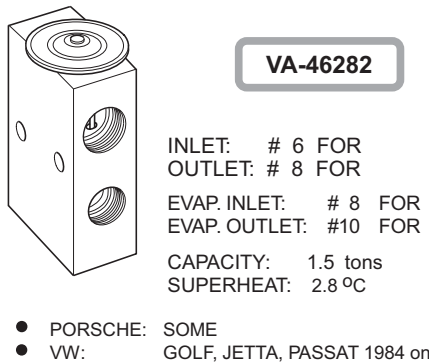

Thermostatic Expansion Valves

BLOCK VALVES - O-RING (Threaded)

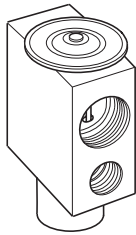

VA-46924

Replaces VA-13567

INLET: # 6 FOR
OUTLET: #10 FOR
EVAP. INLET: # 8 FOR
EVAP. OUTLET: #10 FOR
CAPACITY: 2.0 tons
SUPERHEAT: 3.5 °C

- BMW: 3-SERIES (SOME)
- CASE TRACTORS (SOME MODELS)
- JAGUAR: XJ40, XJ6
- JOHN DEERE: WITH BLOCK VALVE
- MERCEDES: W123 1980 on, W126 81-91
- PORSCHE: LATE MODELS
- RENAULT: 25i

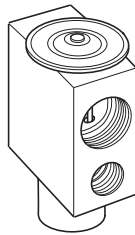

VA-46960

Replaces VA-13560

INLET: # 6 FOR
OUTLET: #10 FOR
EVAP. INLET: #8 FOR
EVAP. OUTLET: #8 FOR
CAPACITY: 2.0 tons
SUPERHEAT: 2.78 °C

- PEUGEOT: 505
- PORSCHE: 928 (EARLY)

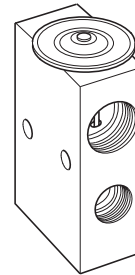

VA-46983

Replaces VA-13770

INLET: # 6 FOR
OUTLET: #10 FOR
EVAP. INLET: # 8 FOR
EVAP. OUTLET: #10 FOR
CAPACITY: 2.0 tons
SUPERHEAT: 2.78 °C

- BERGSTROM: SOME
- KYSOR: SOME
- RED DOT: SOME LATE MODELS

BLOCK TX VALVES - PAD FITTING

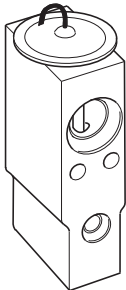

VA-48865

Replaces VA-13865

INLET: # 5 PAD
OUTLET: #10 PAD
EVAP. INLET: #10 PAD
EVAP. OUTLET: #10 PAD
CAPACITY: 2.0 tons
SUPERHEAT: 4.0 °C

- DAIHATSU: MANY
 - SUBARU: LIBERTY 06/94 on
 - TOYOTA: SOME R134a FROM 1994
- REPLACES NIPPON DENSO VALVE IN MANY R134a SYSTEMS.
OE: 447500-0030, 447500-0031, 447500-1031

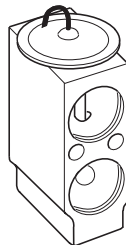

VA-48902

Replaces VA-13738

INLET: # 5 PAD
OUTLET: #10 PAD
EVAP. INLET: 19.4mm PAD
EVAP. OUTLET: 21.4mm PAD

- HYUNDAI EXCEL 1996 ON
LANTRA 1996 ON



VA-48977

INLET: # 5 PAD
OUTLET: #10 PAD
EVAP. INLET: # 8 PAD
EVAP. OUTLET: #10 PAD

- TOYOTA LANDCRUISER 100 SERIES
01/1998 on

REPLACES NIPPON DENSO 447500-1660

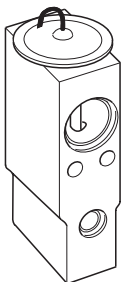

VA-49824

Replaces VA-13824

INLET: # 5 PAD
OUTLET: #10 PAD
EVAP. INLET: 19.5mm PAD
EVAP. OUTLET: #10 PAD
CAPACITY: 2.0 tons
SUPERHEAT: 4.44 °C

- DAIHATSU: SOME
 - SAME: TRACTORS, SOME WITH R12
 - SUBARU: LIBERTY 06/89 - 06/94
 - TOYOTA: VARIOUS
- NOTE: POPULAR REPLACEMENT FOR NIPPON DENSO SYSTEMS ORIGINALLY R12.
OE: 047500-1320, -1330, -1720, -1730

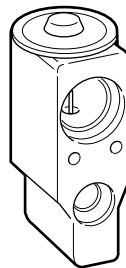

VA-51781

Replaces VA-13781

INLET: # 6 PAD
OUTLET: #12 PAD
EVAP. INLET: # 8 PAD
EVAP. OUTLET: #10 PAD

- SAAB: 900 03/94 - 06/98
9000 to 06/98

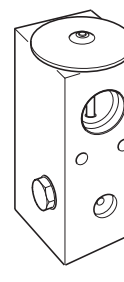

VA-52714

Replaces VA-13714

INLET: 11mm PAD
OUTLET: 20mm PAD
EVAP. INLET: 14mm PAD
EVAP. OUTLET: 20mm PAD
CAPACITY: 1.5 tons
SUPERHEAT: 3.6 °C

- CHRYSLER: NEON 06/96 on

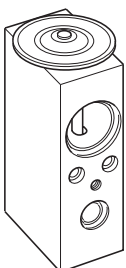

VA-52838

Replaces VA-13736

INLET: # 6 PAD
OUTLET: #12 PAD
EVAP. INLET: # 8 PAD
EVAP. OUTLET: #10 PAD
CAPACITY: 1.5 tons
SUPERHEAT: 29.5 lbs/in²

- GM: COMMODORE: VT, VX, VY

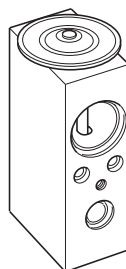

VA-52915

Replaces VA-13544

INLET: # 6 PAD
OUTLET: #10 PAD
EVAP. INLET: # 8 PAD
EVAP. OUTLET: # 8 PAD
CAPACITY: 1.5 tons
SUPERHEAT: 4.44 °C

- MERCEDES: SPRINTER, VITO
- NISSAN: BLUEBIRD 05/83 on
GAZELLE 01/84 on
PINTARA 1989 - 1992
SKYLINE 1986 - 1990

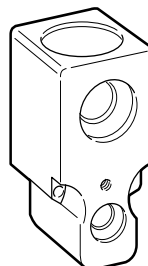

VA-52947

Replaces VA-13960

INLET: # 6 PAD
OUTLET: #12 PAD
EVAP. INLET: # 8 PAD
EVAP. OUTLET: #10 PAD

- AUDI: A3 1996 on
- CITROEN: SOME
- VOLKSWAGEN: GOLF 01/94 on
PASSAT 1992 on
VENTO 01/94 on

Thermostatic Expansion Valves

BLOCK TX VALVES - PAD FITTING

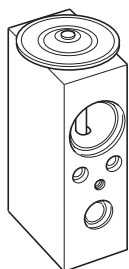

VA-54592

Replaces VA-13592

INLET: # 6 PAD
OUTLET: #10 PAD

EVAP. INLET: # 8 PAD
EVAP. OUTLET: #10 PAD

CAPACITY: 2.5 tons
SUPERHEAT: 2.78 °C

- FORD: FALCON XF, ZL
(Replaces OE # XF19849A; 88DA 19849AA)
- PORSCHE: 928 S4

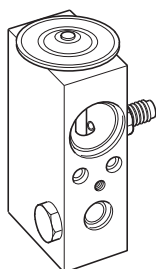

VA-54598

Replaces VA-13598

INLET: # 6 PAD
OUTLET: #10 PAD

EVAP. INLET: # 8 PAD
EVAP. OUTLET: #10 PAD

CAPACITY: 2.5 tons
SUPERHEAT: 2.78 °C

- FORD FALCON EA - EB to 02/92
FAIRLANE NA - NC to 02/92
(REPLACES OE # EA19849AA)
HAS PROVISION FOR HP-LP SWITCH

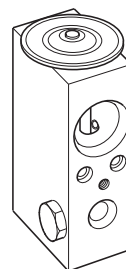

VA-54610

Replaces VA-13610

INLET: # 6 PAD
OUTLET: #10 PAD

EVAP. INLET: # 8 PAD
EVAP. OUTLET: #10 PAD

CAPACITY: 2.5 tons
SUPERHEAT: 2.78 °C

- FORD FALCON: EB II - ED - EF 02/92 on
REPLACES OE # EE19849AA
HAS PROVISION FOR HP-LP SWITCH

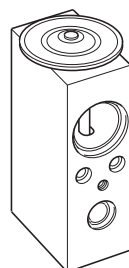

VA-57693

INLET: # 6 PAD
OUTLET: #12 PAD

EVAP. INLET: # 8 PAD
EVAP. OUTLET: #10 PAD

CAPACITY: 1.8 tons

- BMW REPLACES OE: 64118371459

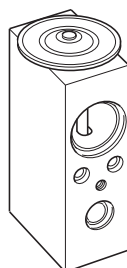

VA-57780

Replaces VA-13780

INLET: # 6 PAD
OUTLET: #12 PAD

EVAP. INLET: # 8 PAD
EVAP. OUTLET: #10 PAD

CAPACITY: 1.7 tons
SUPERHEAT: 4.44 °C

- FENDT: SOME
- G M: ASTRA TR
BARINA SB
- RENAULT: 19
- SAAB: 900, 9000

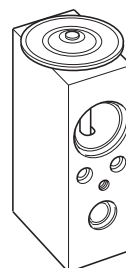

VA-57830

Replaces VA-13700

INLET: # 6 PAD
OUTLET: #12 PAD

EVAP. INLET: # 8 PAD
EVAP. OUTLET: #10 PAD

CAPACITY: 2.0 tons
SUPERHEAT: 3.0 °C

- BMW: SOME LATE MODELS
- G M: COMMODORE: VR - VS
- JOHN DEERE: SOME

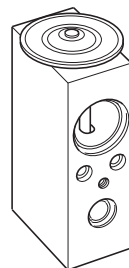

VA-57912

Replaces VA-13750

INLET: # 6 PAD
OUTLET: #12 PAD

EVAP. INLET: # 8 PAD
EVAP. OUTLET: #10 PAD

CAPACITY: 2.0 tons
SUPERHEAT: 6.0 °C

- MERCEDES: W140 1992 on
W201 190 1992 on
W202 C180, C220 1994 on

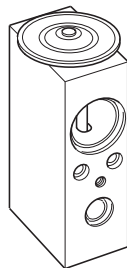

VA-57984

Replaces VA-13753

INLET: # 6 PAD
OUTLET: #12 PAD

EVAP. INLET: # 8 PAD
EVAP. OUTLET: #10 PAD

CAPACITY: 2.0 tons
SUPERHEAT: 3.5 °C

- MERCEDES: W124 TO 1992
W140 TO 1992
W201 TO 1992
- PEUGEOT 405



VA-59965

Replaces VA-13718

INLET: # 8 PAD
OUTLET: #12 PAD

EVAP. INLET: # 8 PAD
EVAP. OUTLET: #12 PAD

CAPACITY: 1.8 tons
SUPERHEAT: 3.6 °C

- CHRYSLER: VOYAGER GS

Technical Tip

Always fit the **CORRECT** TX Valve or Orifice.

Both the rating (capacity) **and** the superheat setting **must** be correct.

Capacity:

TX Valves are rated in tons.

The tonnage of a valve simply refers to its capacity. (1 ton = 12,000 BTU/HR).

A valve which has a rating which is too small for the coil will 'starve' the coil and system performance will be reduced

A valve which is too big for the coil may cause 'flooding' and in extreme cases can cause liquid slugging which can damage the compressor.

Superheat :

If a valve with a superheat setting which is too low for the coil is used, the valve will open too early and flooding may occur.

A valve with a superheat setting too high will not open as early as it should and the coil may be starved, reducing performance.



Valves - in - Receiver (VIR Valves)

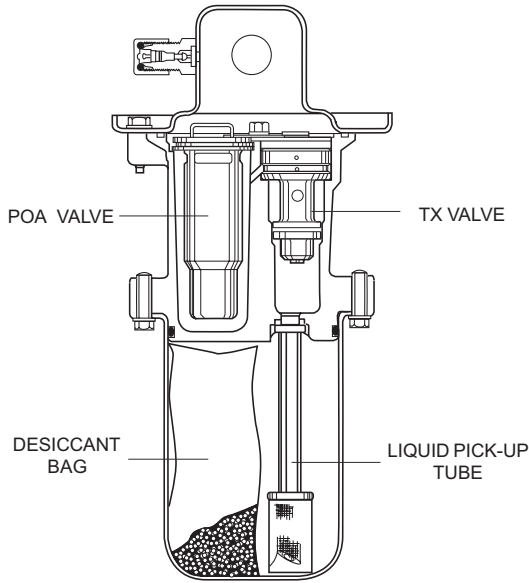

VA-65125
V.I.R. VALVE ASSEMBLY COMPLETE
(RECONDITIONED)

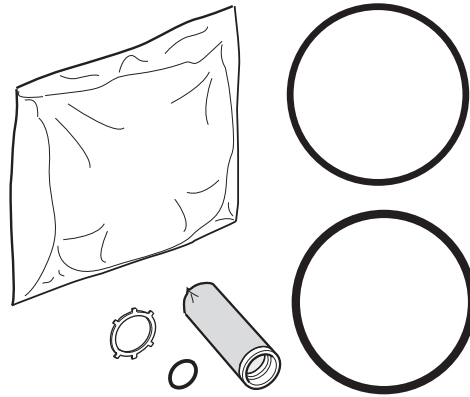

VA-65197
V.I.R.
MAINTENANCE KIT

Valve Spares

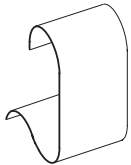

TX VALVE SENSING BULB
CLAMP
VA-83500 - 10mm (3/8")



VO-85055
O-RING - FITS MOST
EQUALIZER TUBES



VO-85080
O-RING, FORD TX
OE: V890136S
PACK OF 20



VO-85110
O-RING, FORD TX
OE: V890138S
PACK OF 20



VO-85145
O-RING TX VALVE
COMMODORE VT - VY
PACK OF 20



VO-85200
FORD TX VALVE O-RING KIT
XF - ALL
XG - TO JULY 1993



VO-85222
FORD TX VALVE O-RING KIT
EA - ALL
EB - EBI - ALL

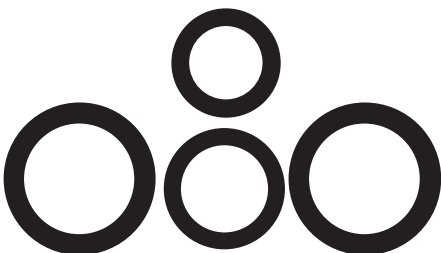

VO-85234
FORD TX VALVE O-RING KIT
EB-II - ED - EF
XG - FROM AUG. 1993

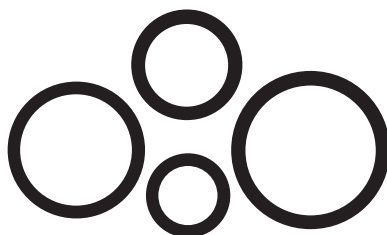

VO-85325
HOLDEN COMMODORE VR - VS
TX VALVE O-RING KIT

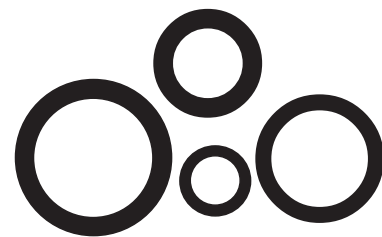

VO-85330
HOLDEN COMMODORE VT - VY
TX VALVE O-RING KIT

NOTE: ALL TX VALVE O-RINGS ABOVE ARE SHOWN ACTUAL SIZE

