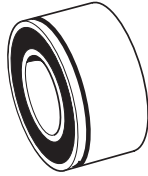

COMPRESSOR SPARES

QUICK - REFERENCE GUIDE

ITEM	DETAILS	PAGE
COMPRESSOR SPARES	- ADAPTORS AND FITTINGS	112 - 113
	- BEARINGS	102
	- CAPS, SERVICE ACCESS	102
	- CORES, ACCESS VALVE	103
	- GASKET KITS	103 - 105
	- GASKETS - MANIFOLD	114
	- CYLINDER HEADS	105 - 106
	- FITTINGS - COMPRESSOR HEAD	119 - 120
	- O-RINGS AND SEALS	115 - 116
	- RETROFIT ADAPTORS, R-12 to R134a	116 - 118
	- SHAFT KEYS	106
	- SHAFT SEAL KITS	107 - 111
	- SENSORS - CLUTCH/BELT SLIP	111
	- SERVICE VALVE ADAPTORS (YORK & TECUMSEH)	112
	- SERVICE FITTINGS (DELCO, N-DENSO, SANDEN)	113
	- SERVICE VALVE GASKETS AND O-RINGS	116
	- VALVES - SERVICE ACCESS R-12	116
	- VALVES - SERVICE ACCESS R134a	116 - 118
	- VALVES - CONTROL (DELPHI)	111
	- VALVES - SERVICE VALVES	119 - 120

Compressor Spares: Bearings, Caps**BEARINGS: CRANKSHAFT**

COS-80505
 SANDEN FRONT CRANKSHAFT BEARING
 SUITS: TRF105
 (DOES NOT SUIT TRS105)
 OE No. 2200-0190

CAPS: SERVICE ACCESS - R12

COS-80794
 CAP
 3/16" R12 SERVICE VALVE
 PLASTIC

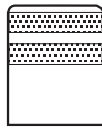

COS-80795
 CAP
 1/4" R12 SERVICE VALVE - BRASS
 PACK of 10

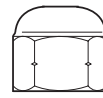

COS-80798
 DISABLE CAP
 3/16" MF R12 SERVICE VALVE

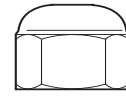

COS-80800
 DISABLE CAP
 1/4" MF R12 SERVICE VALVE

CAP: BACK-SEAT STEM

COS-80805
 BACK-SEAT STEM CAP
 PLASTIC

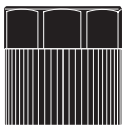
CAPS: SERVICE ACCESS - R134a**Discharge**

COS-80833-6
 (RED)
 Thread: 8mm
 Pack: 6 pcs

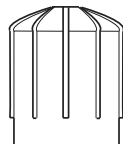

COS-80835-6
 (BLACK)
 Fits: some OEM
 Thread: 3/8" (9.5mm)
 (approx. 7mm deep)
 Pack: 6 pcs

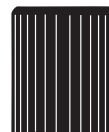

COS-80836-6
 (BLACK)
 Fits: some High-Flow fittings
 Thread: 3/8" (9.5mm)
 (approx. 16mm deep)
 Pack: 6 pcs

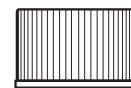

COS-80837-6
 (GREEN or BLACK)
 Fits: Cooltemp, some Ford,
 some Japanese
 Thread: 8mm
 Pack: 6 pcs

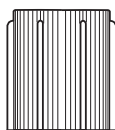
Suction

COS-80841-6
 (LIGHT BLUE)
 Thread: 8mm
 Pack: 6 pcs

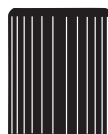

COS-80842-6
 (BLACK)
 Fits: some High-Flow fittings
 Thread: 8mm
 (approx. 17mm deep)
 Pack: 6 pcs

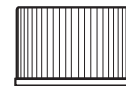

COS-80845-6
 (GREEN or BLACK)
 Fits: Cooltemp, some Ford,
 some Japanese
 Thread: 8mm
 Pack: 6 pcs

Compressor Spares: Cores

ACCESS VALVE CORES

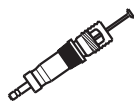

**STANDARD VALVE CORE
R-12 AND R134a**
SUITS STANDARD R-12 3/16" MF
AND 1/4" MF ACCESS PORTS.
ALSO SUITS R134a ACCESS
PORTS WITH STANDARD CORE.
COS-80850 - PACK OF 6
COS-80860 - PACK OF 100

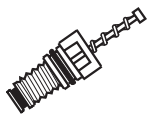

**JAPANESE HIGH-FLOW VALVE
CORE. R134a ONLY**
SUITS ATCO AND MANY
JAPANESE R134a FITTINGS
WITH HIGH-FLOW VALVE CORES.

COS-80866 - PACK OF 6

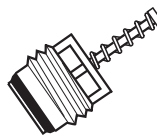

**HIGH-FLOW VALVE CORE
R134a DISCHARGE ONLY**
SUITS SOME R134a
DISCHARGE FITTINGS WITH
HIGH-FLOW VALVE CORES.

COS-80875 - SINGLE CORE
COS-80880 - PACK OF 6

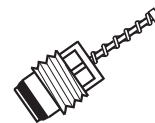

**HIGH-FLOW VALVE CORE
R134a SUCTION ONLY**
SUITS SOME R134a SUCTION
FITTINGS WITH HIGH-FLOW
VALVE CORES.

COS-80885 - SINGLE CORE
COS-80890 - PACK OF 6

NOTE: CORES ILLUSTRATED ARE ACTUAL SIZE

Compressor Spares: Gasket Kits

DELCO (HARRISON)

Delco A 6

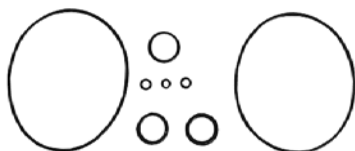

**COS-81206
R134a (HNBR)**

DELCO (HARRISON) A6 REPLACES OE: 15-237

Delco R 4

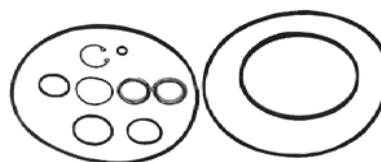

**COS-81215
R134a (HNBR)**

DELCO (HARRISON) R4

NIPPON - DENSO

6E 171, 6E 171A

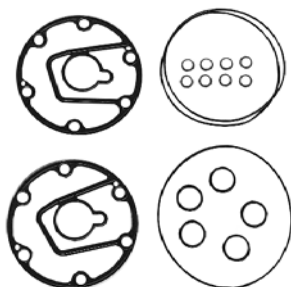

COS-81380
NIPPON DENSO 6E171
REPLACES OE: 047299-0280

6P127A, 6P127B

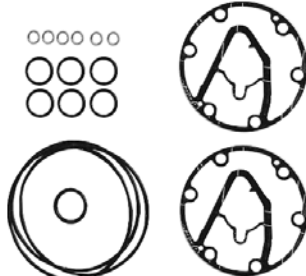

COS-81390
NIPPON DENSO 6P127A & B
REPLACES OE: 042705-0040

6P134

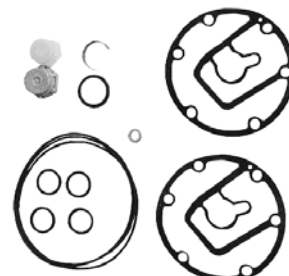

COS-81398
NIPPON DENSO 6P134
REPLACES OE: 047299-0160

6P148A

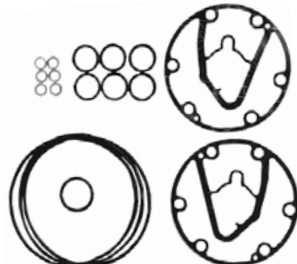

COS-81405
NIPPON DENSO 6P148A
REPLACES OE: 047299-0290

10P 08E

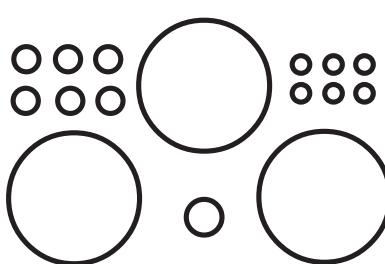

COS-81411
NIPPON DENSO 10P08E

10P 13, 10P 15

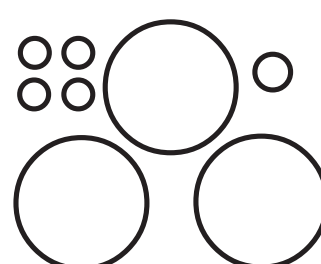

COS-81415
NIPPON DENSO 10P13, 10P15
REPLACES OE: 047299-0420

Compressor Spares: Gasket Kits

NIPPON-DENSO

10P 17C

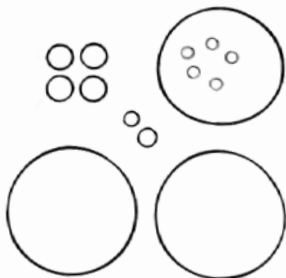

COS-81430
NIPPO-DENSO 10P17C

10PA 15, 17, 17C

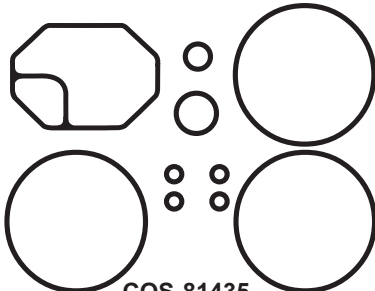

COS-81435
NIPPO-DENSO
10PA15, 10PA17, 10PA17C

TV12C, TV14C

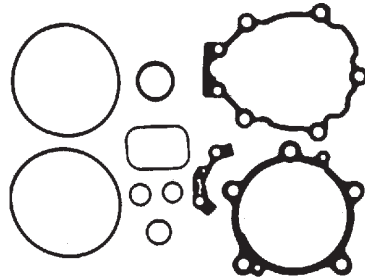

COS-81466
NIPPO-DENSO TV12C, TV14C

SANDEN

SD5 Series

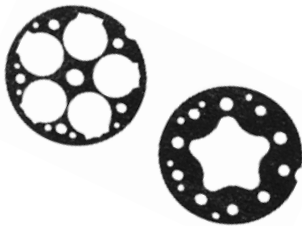

COS-81566
SANDEN SD-5 SERIES (1979 ON)
SANDEN 8385-9611
NOTE: DOES NOT SUIT SD5H09

SD7 Series (R12)



COS-81569
SANDEN SD-7 SERIES - R12 only
SANDEN 7200-9610

SD7H15 Type B (R134a)



COS-81572
SANDEN SD7H15 TYPE B - R134a
SANDEN 7902-9610

SD7H15 Type C (R134a)

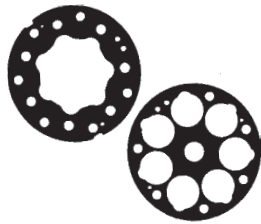

COS-81573
SANDEN SD7H15 TYPE C - R134a
SANDEN 8002-9610

SD7V16 Series (R134a)

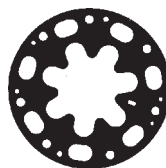

COS-81574
SANDEN SD7V16 SERIES - R134a
SANDEN 1001-0440

SEIKO - SEIKI

110, 140, 170 Series

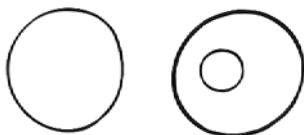

COS-81580
SEIKO - SEIKI 110, 140 & 170 SERIES

TECUMSEH

HG1000, HGB1000

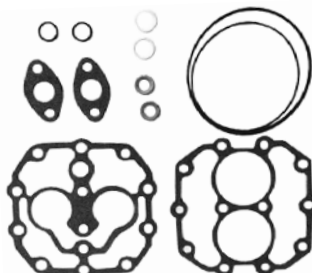

COS-81610
TECUMSEH HG1000 & HGB1000

Compressor Spares: Gasket Kits

UNICLA

UPS Series



COS-81798
UNICLA UPS107 AND UPS109

YORK

206, 209 and 210

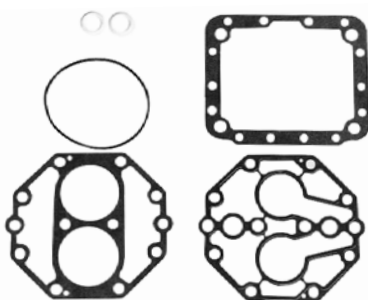

COS-81895
YORK 206, 209, 210 SERIES
SUITS ROTOLOCK HEAD COMPRESSORS
REPLACES OE: 488-16316

(FOR FLANGE HEAD COMPRESSORS,
ALSO ORDER 2pcs COS-95420)

Compressor Spares: Heads

SANDEN

SD5 Series

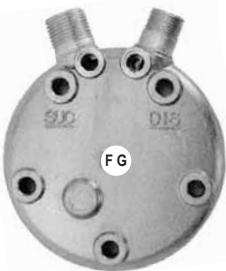

COS-82579
VERTICAL O-RING (MIOR)
FITS: SD508 & SD510 MODELS
SANDEN: 9539-0450



COS-82583
VERTICAL TUBE - O
FITS: SD508 & SD510 MODELS
SANDEN: 8476-9631



COS-82588
REAR TUBE - O
FITS: SD508 & SD510 MODELS
SANDEN: 8489-9631

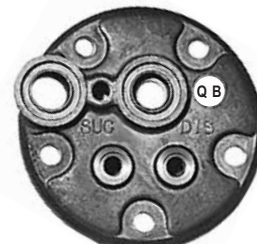

COS-82590
G.M. PAD FITTING
FITS: SD510 MODELS
SANDEN: 9652-0450
(NOTE: DOES NOT SUIT ALL
DELCO A6 APPLICATIONS)

Cylinder Head Access Fittings

(order separately if required)

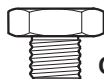

COS-83634
access port
blank-off plug

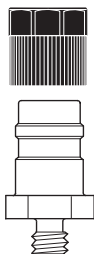

COS-96874
R134a high-side
access fitting

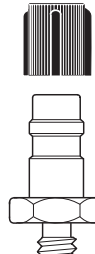

COS-96890
R134a low-side
access fitting

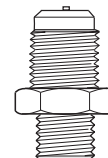

COS-96800
R12 access fitting
(1/4" dill valve)

Compressor Spares: Heads

SANDEN . . . cont'd.

SD7 Series



COS-82600 (R134a)
VERTICAL O-RING (MIOR)
 FITS: SD 709, SD7H13/15
 SANDEN: 7223-9630

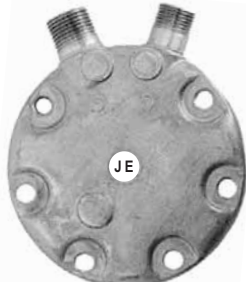

COS-82602 (R134a)
VERTICAL O-RING (MIOR)
 FITS: SD 709, SD7H13/15
 SANDEN: 7863-9630



COS-82603 (R134A)
VERTICAL TUBE- O
 FITS: SD 709, SD7H13/15
 SANDEN: 7401-0451

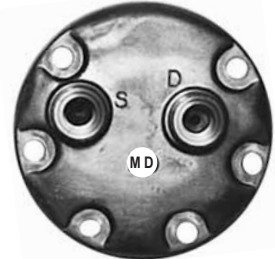

COS-82605 (R134a)
REAR TUBE- O
 FITS: SD 709, SD7H13/15
 SANDEN: 7402-9630



COS-82608 (R134a)
REAR O-RING
 FITS: SD 709, SD7H13/15
 SANDEN: 7862-0450



COS-82614 (R134a)
G.M. PAD FITTING
 FITS: SD 709, SD7H13/15
 SANDEN: 7400-9630

Cylinder Head Access Fittings

(order separately if required)



COS-83634
 access port
 blank-off plug

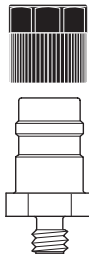

COS-96874
 R134a high-side
 access fitting

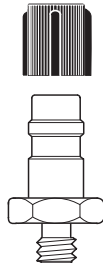

COS-96890
 R134a low-side
 access fitting

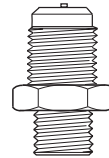

COS-96800
 R12 access fitting
 (1/4" dill valve)

YORK

209 and 210 Series



COS-82792
YORK ROTOLock
 FITS ALL 209 AND 210 SERIES
 YORK COMPRESSORS

Compressor Spares: Shaft Keys

SHAFT KEYS

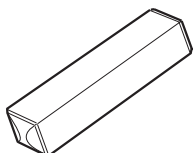

COS-83025
 DELCO A6 SHAFT KEY

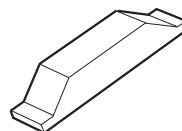

COS-83100
 YORK AND TECUMSEH
 SHAFT KEY

Compressor Spares: Shaft Seals

DELCO / DELPHI

A6, early R4

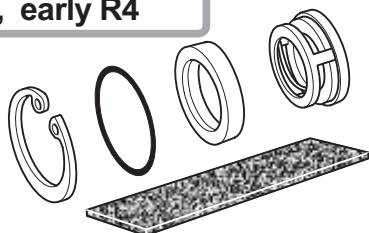

COS-84205

SUITS: ALL DELCO A6 AND EARLY R4 WITH CERAMIC SEAL
REPLACES OE 6599114

R4, early V5

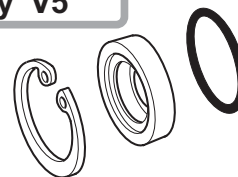

COS-84220

SUITS: DELCO R4 LATE (1987 on) SHORT SHAFT WITH 'LIP' TYPE SEAL
DELPHI V5 (EARLY VT COMMODORE)
HR6

V5 double lip seal



COS-84233

SUITS: DELPHI V5 WITH DOUBLE LIP TYPE SEAL.
COMMODORE: LATE VT, VX, VY

DIESEL - KIKI

DKS12, DKS15



COS-84265

SUITS: MOST EARLY DKS12 AND DKS15 SERIES WITH KEYED SHAFT.

**DKS12, DKS15 'BH',
some DKV14C**

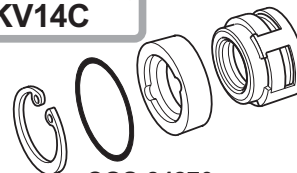

COS-84270

SUITS: DKS12 AND DKS15 'BH' SERIES COMPRESSORS
(with splined shaft and bolt-type clutch)
DKV14C (some)

DKS12, DKS15 'CH'



COS-84275

SUITS: LATE DKS SERIES 'CH' COMPRESSORS
(with lip-type seal and keyed shaft with nut-type clutch)

HALLA

FX15 double lip seal

COS-84301

SUITS: FX15 WITH DOUBLE LIP TYPE SEAL.
FALCON AU

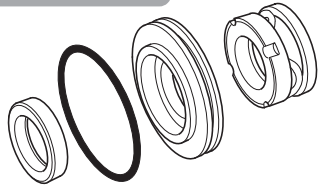

Compressor Spares: Shaft Seals**NIPPON - DENSO . . cont'd.****2M 110****COS-84355**

SUITS: 2M110 SERIES COMPRESSORS

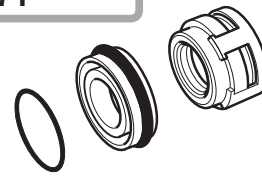
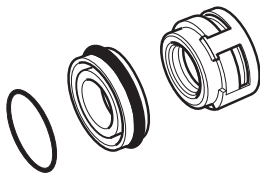
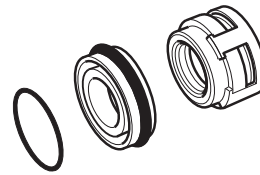
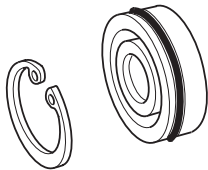
6E 171**COS-84380**SUITS: 6E171 SERIES
(MAY INCLUDE FRONT GASKETS)
NOTE: CAN USE COS-84410**6P 134****COS-84396**SUITS: 6P134 SERIES
(INCLUDES FRONT GASKETS)
NOTE: CAN USE COS-84410**6P 148****COS-84398**SUITS: 6P148 SERIES
(INCLUDES FRONT GASKETS)
NOTE: CAN USE COS-84410**10P 08E****COS-84407**

SUITS: 10P08E SERIES WITH LIP - TYPE SEAL

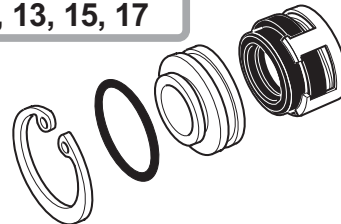
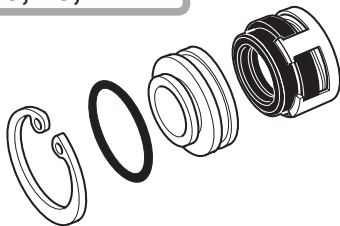
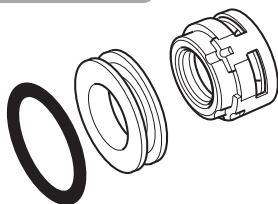
10P08, 13, 15, 17**COS-84410**SUITS: 10P08, 10P13, 10P15, 10P17 MODELS WITH MECHANICAL SEAL
6P127, 6P134, 6P148, 6E171, 6E171A MODELS
AFTERMARKET - MADE IN USA**10P13, 15, 17****COS-84412**SUITS: 10P13, 10P15, 10P17 SERIES; MECHANICAL SEAL
PREMIUM QUALITY - MADE IN JAPAN**10PA15, 17, 20****COS-84415**SUITS: 10PA15; 10PA17, 10PA20 SERIES; LIP-TYPE
REPLACES: OE: 047040-0270 & 047299-0770**10P 25****COS-84425**SUITS: 10P25 SERIES
REPLACES: OE: 047040-0230; 047299-0651

Compressor Spares: Shaft Seals

NIPPON - DENSO . . . cont'd.

TV10, TV10CB

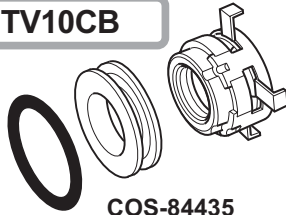

COS-84435

SUITS: TV10, TV10CB (R134a MODELS ONLY) MECHANICAL SEAL

TV12C, TV14C

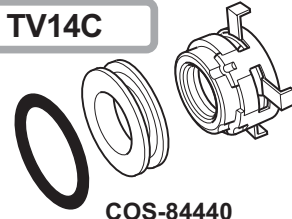

COS-84440

SUITS: TV12C, TV14C (R12 MODELS ONLY) MECHANICAL SEAL

PANASONIC (Matsushita)

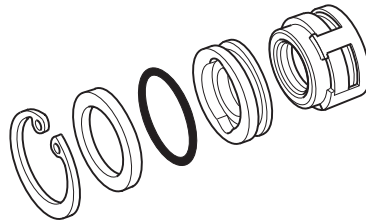

COS-84483

SUITS: PANASONIC - MOST LATE MODELS

SANDEN

SD505, SD507(late)

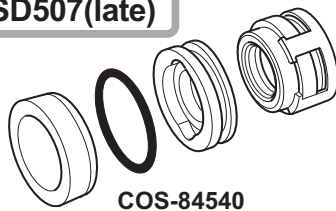

COS-84540

SUITS: SD505 (ALL),
LATE SD507 WITH GOLD CLUTCH
SANDEN: 9051-9830

SD507, 508, 510

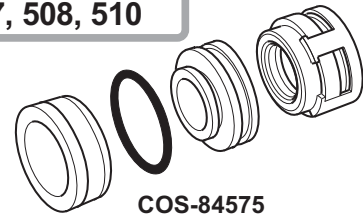

COS-84575

SUITS: EARLY SD507 (silver clutch),
ALL SD508 / SD510 MODELS
SANDEN: 8385-9830

SD709 Series

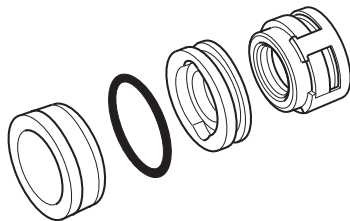

COS-84591

SUITS: SD709 SERIES - R-12 ONLY
SANDEN: 7413-9830

SDB7, SD7B, SD5H09

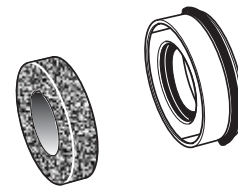

COS-84592

SUITS: SDB7, SD5H09 R12 and R134a
ALTERNATOR MOUNT
SANDEN: 7150-9830

**SD5H14 with 8N code
SD7H series
SD7V16 (some)**



COS-84593

SUITS: SD5H14 (see note), SD7H (see note), SD7HC SERIES; R134a
SD7V16 (some)
SANDEN: 8002-9830

NOTE: SUITS SD5H14 with body code 8N (stamped on mounting lug).
Does NOT suit SD7H13 D-Series with model code 8000 on.

**SD5H14 (late)
SD7H13 D series
SD7V16 (some)**



COS-84594

SUITS: SD5H14 with body code 84 (stamped on mounting lug)
SD7H13 D-Series with model code 8000 on.
SD7V16 (some)

SANDEN: 8900-9830

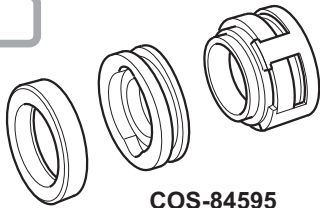
Compressor Spares: Shaft Seals**SANDEN****TR70 Series****COS-83325 o-ring**
(order separately)**COS-84595**
(seal kit)

SUITS: TR70 TURBO (SCROLL)
SANDEN: 9751-9830-70

NOTE: COS-83325 O-RING IS NOT INCLUDED WITH THE SEAL, BUT IS NORMALLY REQUIRED - PLEASE ORDER SEPARATELY.

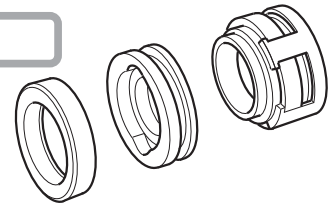
TR90 Series**COS-83332 o-ring**
(order separately)**COS-84598Z** (seal kit)

SUITS: TR90 TURBO (SCROLL)
SANDEN: 9751-9830-90

NOTE: COS-83332 O-RING IS NOT INCLUDED WITH THE SEAL, BUT IS NORMALLY REQUIRED - PLEASE ORDER SEPARATELY.

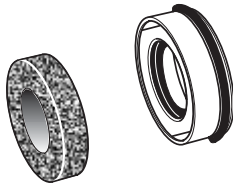
TRF105 Series**COS-84601**

SUITS: TRF105 TURBO (SCROLL)
SANDEN: 2300-9840

(IF CRANKSHAFT BEARING IS REQUIRED, ORDER COS-80505)

**TRS 90, TRS105,
TRV105****COS-84602**

SUITS: TRS90, TRS105, TRV105 TURBO (SCROLL)
(BEARING IS INCLUDED)

SANDEN: 2550-9960

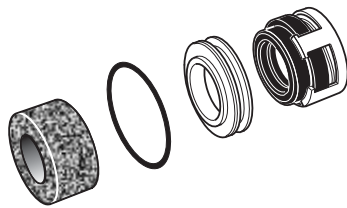
SEIKO - SEIKI**Early Seat Type****COS-84605**

SUITS: 110, 140, 170 PSV SERIES SEAT TYPE SEAL TO JAN. 1991

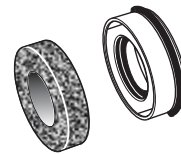
Lip Type**COS-84607**

SUITS: 110, 140, 170 PSV SERIES LIP TYPE SEAL AFTER JAN. 1991
99, 121 SERIES (ALL)

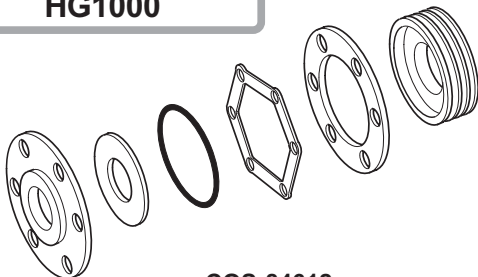
TECUMSEH**HG1000****COS-84612**

SUITS: EARLY HG1000 WITH CAST SEAL PLATE AND
6 x 9/32" BOLT HOLES

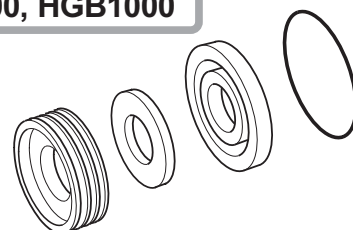
HG1000, HGB1000**COS-84620**

SUITS: LATE HG1000 AND HGB1000 WITH PRESSED SEAL COVER
PLATE WITH 6 x 7/32" BOLT HOLES

Compressor Spares: Shaft Seals

UNICLA

DA 299



COS-84777

SUITS: DA299 (DISCONTINUED - USE COS-84882)

UPS 107, 109



COS-84798

SUITS: ALL UPS107 AND UPS109 SERIES

YORK (CCI)

206, 209, 210 (late)

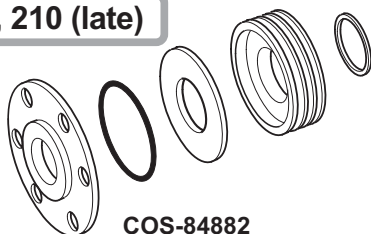

COS-84882

SUITS: ALL LATE YORK RECIPROCATING MODELS WITH CAST SEAL COVER PLATE WITH 6 x 7/32" BOLT HOLES R134a COMPATIBLE

206, 209, 210 (early)



COS-84892

SUITS: ALL EARLY YORK RECIPROCATING MODELS WITH CAST SEAL COVER PLATE WITH 5 x 9/32" BOLT HOLES R134a COMPATIBLE

Compressor Spares: Sensors - Belt Slip

NIPPON DENSO SLIP SENSORS



TYPICAL CLUTCH SLIP SENSOR

COS-86402	TOYOTA	CAMRY	SV11
COS-86410	TOYOTA	CAMRY	SV21
COS-86421	TOYOTA	CAMRY	SDV10
COS-86444	TOYOTA	CELICA	ST162
COS-86453	TOYOTA	COROLLA	AE82

THESE SENSORS ARE USED TO DETECT COMPRESSOR LOCK-UP, AND CONSEQUENT BELT SLIP, ON VEHICLES WHICH SHARE A COMMON BELT TO DRIVE THE COMPRESSOR AND THE POWER STEERING PUMP.

SLIP SENSORS MONITOR THE ROTATION OF THE COMPRESSOR BY SENSING AN ELECTRICAL CURRENT GENERATED BY A MAGNET IN THE SWASH PLATE, AND A CORE AND COIL IN THE ROTATION SENSOR. THIS IS COMPARED WITH THE ENGINE RPM AND AN INDICATOR LIGHT FLASHES A WARNING WHEN SLIPPAGE EXCEEDS THE ACCEPTABLE RATE

Compressor Spares: Control Valves

DELPHI PRESSURE CONTROL VALVES



TYPICAL CONTROL VALVE

COS-88914	40 psia	YELLOW	-	DAEWOO	LANOS, LEGANZA, NUBIRA
COS-88921	41 psia	PURPLE	-	C/DORE	VT - VY V8
COS-88928	42 psia	BLUE	-	C/DORE	VT - VY V6,
				CIELO	
COS-88935	43 psia	BROWN	-	BARINA	SB (Australian air)
COS-88942	44 psia	RED	-	ASTRA	TR
				BARINA	SB (imported air)
				VECTRA	JR, JS

Compressor Spares: Adaptors & Fittings

FORD COMPRESSOR ADAPTOR

Ford ED to EA Adaptor

COS-92710

FALCON ED COMPRESSOR TO EA

ADAPTS: COR-32468Z ED COMPRESSOR TO ENABLE CONNECTION OF EARLIER EA HOSE ASSEMBLY.

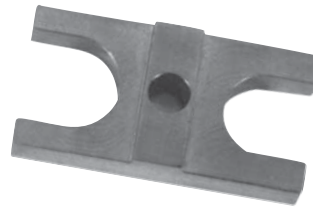

HEAD / FITTING ADAPTORS

Fitting Identification

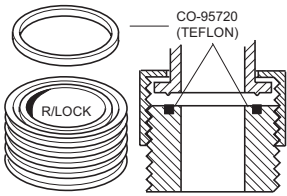

ROTOLOCK FITTING

COMMON FITTING ON TECUMSEH AND YORK RECIPROCATING COMPRESSORS AND SOME SANDEN MODELS. (USE COS-95720 SQUARE CUT TEFLON O-RING)

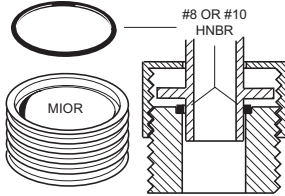

FEMALE O-RING (FOR)

CAN BE USED ON SANDEN AND OTHER COMPRESSORS WITH MIOR FITTINGS TO ENABLE THE USE OF SERVICE VALVES. (USE APPROPRIATE #8 OR #10 HOSE FITTING O-RING)

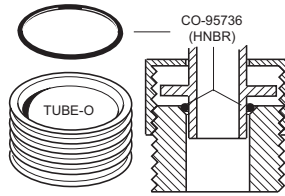

YORK TUBE - O

COMMON FITTING ON SOME OEM WITH YORK COMPRESSORS. (USE COS-95736 HNBR O-RING)

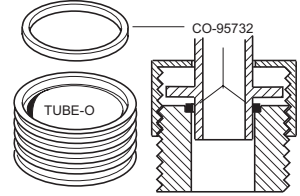

SANDEN TUBE - O

USED ON SOME SANDEN COMPRESSORS TO ENABLE THE USE OF SERVICE VALVES. (USE COS-95732 O-RING)

Rotolock & Tube-O Adaptors

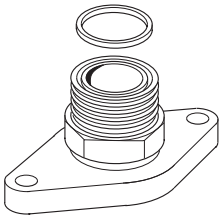

COS-92828

FLANGE to ROTOLOCK

ADAPTS FLANGE TO STANDARD MALE ROTOLOCK FITTING (USE COS-95720 TEFLON SEAL)

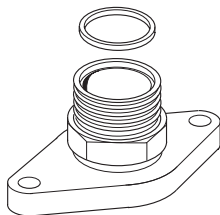

COS-92840

FLANGE to TUBE - O

ADAPTS FLANGE TO SANDEN TYPE MALE TUBE-O FITTING (USE COS-95732 O-RING)

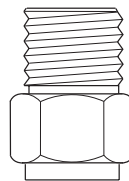

COS-92860

ROTOLOCK to TUBE - O

ADAPTS STANDARD ROTOLOCK TO TUBE-O

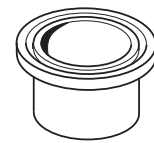

COS-92875

TUBE - O to ROTOLOCK

ADAPTS TUBE-O TO ROTOLOCK

MOUNTING BOLT KIT: DELCO

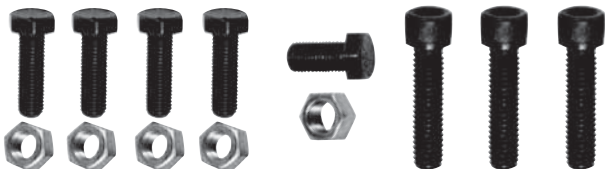

COS-92966

DELCO A6 METRIC COMPRESSOR MOUNTING KIT

COMPLETE SET OF BOLTS AND NUTS REQUIRED TO MOUNT A DELCO A6 METRIC COMPRESSOR.

Compressor Service Fittings

DELCO (HARRISON)

STRAIGHT BLOCK FITTING WITH R-12 1/4" MF SERVICE VALVE
 COS-93275 - # 8 BARB
 COS-93288 - #10 BARB
 COS-93292 - #12 BARB

90 deg. BLOCK FITTING WITH R-12 1/4" MF SERVICE VALVE
 COS-93328 - # 8 BARB
 COS-93330 - #10 BARB
 COS-93332 - #12 BARB

90 deg. REVERSE BLOCK FITTING WITH R-12 1/4" MF SERVICE VALVE
 COS-93350 - #10 BARB
 COS-93352 - #12 BARB

STRAIGHT DUAL FITTING
 COS-93442 - # 8 & #12 BEADLOCK

DUAL 90 deg. FITTING
 COS-93458 - # 8 & #12 BEADLOCK

180 DEGREE DUAL FITTING
 COS-93472 # 8 & #12 BEADLOCK

90 deg. BLOCK FITTING WITH R-12 1/4" MF SERVICE VALVE
 COS-93558 - # 8 BEADLOCK
 COS-93560 - #10 BEADLOCK
 COS-93562 - #12 BEADLOCK

90 deg. REVERSE BLOCK FITTING WITH R-12 1/4" MF SERVICE VALVE
 COS-93568 - # 8 BEADLOCK
 COS-93570 - #10 BEADLOCK
 COS-93572 - #12 BEADLOCK

NIPPON-DENSO

COS-94008
 R12 PAD to No.8 MIOR DISCHARGE FITTING

COS-94010
 R12 PAD to No.10 MIOR SUCTION FITTING

COS-94028Z
 R134a PAD to No. 8 MIOR DISCHARGE FITTING

NOTE: Please check the diagrams carefully; some late model fittings are not compatible.

COS-94030
 R134a PAD to No.10 MIOR SUCTION FITTING

COS-94042
 R12 PAD to R134a CONVERSION FITTING
 (set of both suction and discharge fittings)

COS-94043
 R134a PAD to R12 CONVERSION FITTING
 (set of both suction and discharge fittings)

SANDEN

COS-94080
 SANDEN DISCHARGE (#8) PAD FITTING.
 Suits: TR090, some TR105
 Sanden: 2011-1130
 (use COS-92925 retaining bolt)

COS-94090
 SANDEN SUCTION (#10) PAD FITTING.
 Suits: TR090, some TR105
 Sanden: 2011-1140
 (use COS-92925 retaining bolt)

COS-94098
 SANDEN DISCHARGE (#8) PAD FITTING.
 Suits: SDB Series
 Sanden: S1452-40130
 (use 8mm x 1.25 retaining bolt)

COS-94100
 SANDEN SUCTION (#10) PAD FITTING.
 Suits: SDB Series
 Sanden: S1452-40120
 (use 8mm x 1.25 retaining bolt)

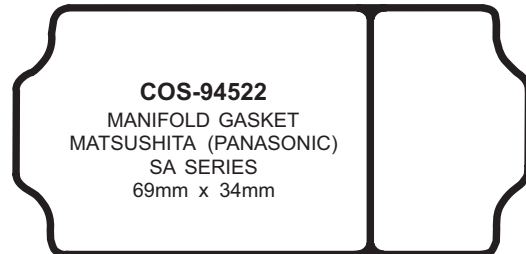
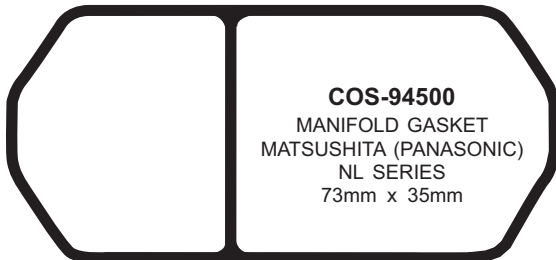
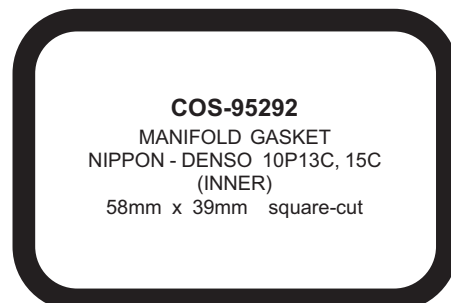
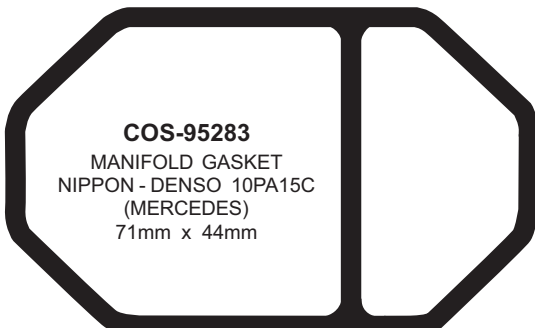
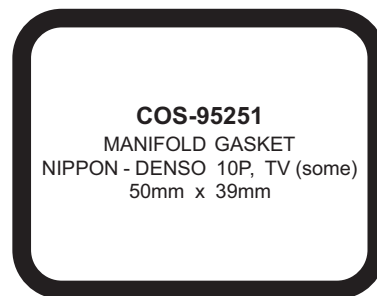
Compressor Spares: Gaskets & O-Rings**MANIFOLD GASKETS****Panasonic (Matsushita)****Nippon - Denso**

ALL GASKETS AND O-RINGS ARE SHOWN ACTUAL SIZE

Compressor Spares: Gaskets & O-Rings

GASKETS, O-RINGS and SEALS

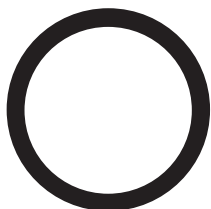

COS-83270
DELCO A6 SUPERHEAT
O-RING
(ORDER COS-81206
O-RING KIT)



COS-83325
SANDEN TR70 SHAFT SEAL
O-RING



COS-83332
SANDEN TR90 SHAFT SEAL
O-RING

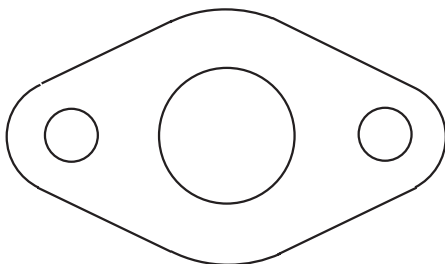

COS-95420
YORK FLANGE SERVICE VALVE GASKET

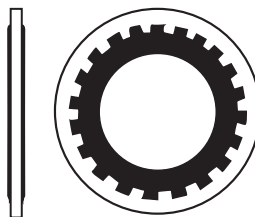

COS-95662
DELCO V5
SUITS: BARINA SB
COMMODORE VT, VX, VY
SET of 2

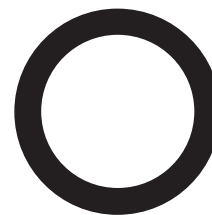

COS-95672
DELCO A6 SERVICE
PAD O-RING (HNBR)
PACK of 10

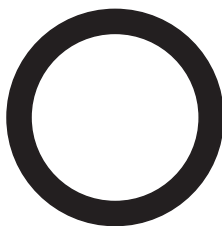

COS-95675
DELCO R4 SERVICE
PAD O-RING (HNBR)
PACK of 10



COS-95677
DELCO R4 (LATE)
SERVICE PAD SEAL.
SET of 2

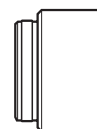
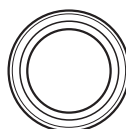

COS-95678
DELCO R4 (LATE)
SERVICE PAD SEAL KIT

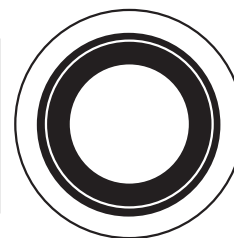
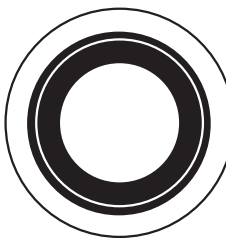
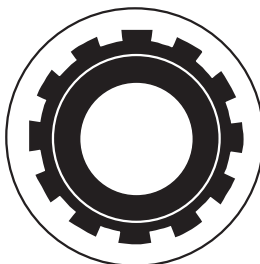

ALL GASKETS AND O-RINGS ARE SHOWN ACTUAL SIZE

Compressor Spares: Gaskets & O-Rings

GASKETS, O-RINGS and SEALS



COS-95680
SANDEN TR
DISCHARGE PAD
O-RING (9751-0050)
PACK of 10

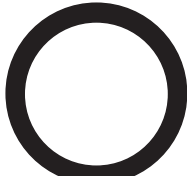

COS-95685
SANDEN TR
SUCTION PAD
O-RING (9029-0500)
ALSO STD. N-DENSO PAD
PACK of 10

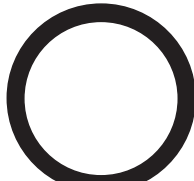

COS-95695
YORK FLANGE
SERVICE VALVE O-RING
(SQUARE-CUT RUBBER)
PACK of 10

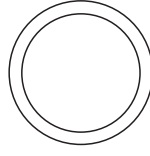

COS-95720
STANDARD ROTOLock
SERVICE VALVE O-RING
(SQUARE-CUT TEFLON)
PACK of 10

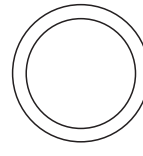

COS-95732
SANDEN TUBE-O
SERVICE VALVE O-RING
PACK of 10



COS-95736
YORK TUBE-O
SERVICE VALVE
O-RING (HNBR)
PACK of 10

ALL GASKETS AND O-RINGS ARE SHOWN ACTUAL SIZE

Compressor Spares: Service Access Valves

R12 SERVICE ACCESS VALVES

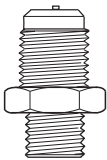

COS-96800
R-12 ACCESS VALVE
REPLACEMENT 1/4" MF R-12 ACCESS VALVE.
1/4" PAR. BSP BASE - 7/16" 20 UNF MF SCHRADER
ACCESS VALVE

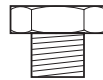

COS-83634
**ACCESS VALVE
BLANKING PLUG**
REPLACES STANDARD R-12 ACCESS PORT WHEN
REMOVED FOR RETROFITTING.
1/4" PAR. BSP

R12 to R134a RETROFIT ADAPTORS

3/16" High Side Adaptors



COS-96850

**STRAIGHT BRASS ACCESS VALVE
ADAPTOR**

CONVERTS STANDARD R-12 3/16" MF ACCESS
VALVE TO R134a DISCHARGE PORT.
FITTING HAS INTEGRAL VALVE CORE - ORIGINAL
CORE IS REMOVED PRIOR TO FITMENT.
(INCLUDES COS-80833 CAP)



COS-96851 (single)
COS-96851-6 (pack of 6)

**STRAIGHT ALLOY ACCESS VALVE
ADAPTOR**

CONVERTS STANDARD R-12 3/16" MF ACCESS
VALVE TO R134a DISCHARGE PORT.
VERY COMPACT FITTING.
USES ORIGINAL VALVE CORE
(INCLUDES COS-80833 CAP)

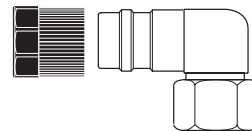

COS-96854 (single)
COS-96854-6 (pack of 6)

**90 DEGREE STEEL ACCESS VALVE
ADAPTOR**

CONVERTS STANDARD R-12 3/16" MF ACCESS
VALVE TO R134a DISCHARGE PORT.
FITTING HAS INTEGRAL VALVE CORE - ORIGINAL
CORE IS REMOVED PRIOR TO FITMENT.
(INCLUDES COS-80833 CAP)

3/16" Retrofit Adaptor with Switch Port

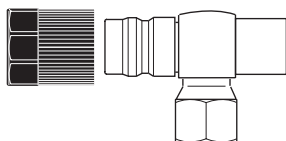

COS-96858

R134a DISCHARGE (HIGH SIDE) ACCESS VALVE ADAPTOR

CONVERTS R12 3/16" ACCESS PORT TO R134a ACCESS AND
ALLOWS FITMENT OF MALE SWITCH.
FITTING HAS INTEGRAL VALVE CORE
(INCLUDES COS-80833 CAP)

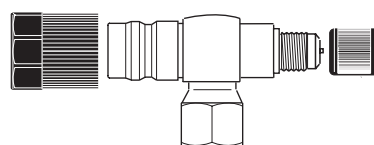

COS-96859

R134a DISCHARGE (HIGH SIDE) ACCESS VALVE ADAPTOR

CONVERTS R12 3/16" ACCESS PORT TO R134a ACCESS AND
ALLOWS FITMENT OF FEMALE SWITCH.
FITTING HAS INTEGRAL VALVE CORE
(INCLUDES COS-80833 CAP)

Compressor Spares: Service Access Valves

R12 to R134a RETROFIT ADAPTORS

1/4" High Side Adaptors

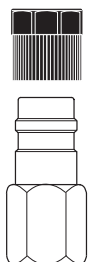

COS-96862

STRAIGHT BRASS ACCESS VALVE ADAPTOR

CONVERTS STANDARD R-12 1/4" MF ACCESS VALVE TO R134a DISCHARGE ACCESS FITTING. **HAS INTEGRAL VALVE CORE** - ORIGINAL CORE IS REMOVED PRIOR TO FITMENT. (HAS COS-80833 CAP)

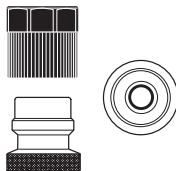

COS-96864 (single)
COS-96864-6 (pack of 6)

STRAIGHT ALLOY ACCESS VALVE ADAPTOR

CONVERTS STANDARD R-12 1/4" MF ACCESS VALVE TO R134a DISCHARGE ACCESS VERY COMPACT FITTING. **USES ORIGINAL VALVE CORE** (HAS CO-80833 CAP)

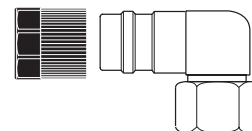

COS-96867 (single)
COS-96867-6 (pack of 6)

90 DEGREE STEEL ACCESS VALVE ADAPTOR

CONVERTS STANDARD R-12 1/4" MF ACCESS PORT TO R134a DISCHARGE ACCESS. **FITTING HAS INTEGRAL VALVE CORE** - ORIGINAL VALVE CORE IS REMOVED PRIOR TO FITMENT. (INCLUDES COS-80833 CAP)

1/4" Retrofit Adaptor with Switch Port

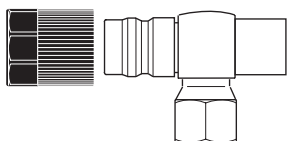

COS-96868

R134a DISCHARGE (HIGH SIDE) ACCESS VALVE ADAPTOR

CONVERTS R12 1/4" ACCESS PORT TO R134a ACCESS AND ALLOWS FITMENT OF MALE SWITCH.

FITTING HAS INTEGRAL VALVE CORE (INCLUDES COS-80833 CAP)

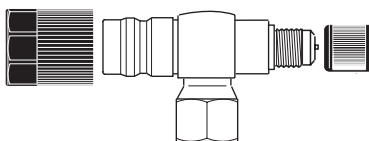

COS-96869

R134a DISCHARGE (HIGH SIDE) ACCESS VALVE ADAPTOR

CONVERTS R12 1/4" ACCESS PORT TO R134a ACCESS AND ALLOWS FITMENT OF FEMALE SWITCH.

FITTING HAS INTEGRAL VALVE CORE (INCLUDES COS-80833 CAP)

Pressure Switch Port Adaptor

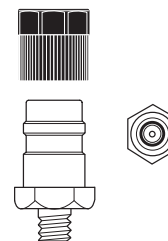

COS-96870

R134a DISCHARGE (HIGH SIDE) ACCESS VALVE ADAPTOR

SCREWS DIRECTLY INTO STANDARD SWITCH PORT AND CONVERTS TO R134a HIGH SIDE ACCESS.

FITTING HAS INTEGRAL VALVE CORE. (INCLUDES COS-80833 CAP)

Compressor R134a High Side

Sanden

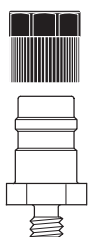

COS-96874

R134a DISCHARGE (HIGH SIDE) SANDEN ACCESS VALVE ADAPTOR

SCREWS DIRECTLY INTO STANDARD SANDEN COMPRESSOR HEAD AND REPLACES ORIGINAL R-12 ACCESS PORT.

FITTING HAS INTEGRAL VALVE CORE. (INCLUDES COS-80837 CAP)

Seiko-Seiki



COS-96876

R134a DISCHARGE (HIGH SIDE) SEIKO-SEIKI ACCESS VALVE ADAPTOR

SCREWS DIRECTLY INTO STANDARD SANDEN COMPRESSOR HEAD AND REPLACES ORIGINAL R-12 ACCESS PORT.

FITTING HAS INTEGRAL VALVE CORE. (INCLUDES COS-80837 CAP)

Compressor Spares: Service Access Valves**R12 to R134a RETROFIT ADAPTORS****1/4" Low Side Adaptors**

COS-96882 (single)
COS-96882-6 (pack of 6)

STRAIGHT STEEL ACCESS VALVE ADAPTOR

CONVERTS STANDARD R-12 1/4" MF
 ACCESS TO R134a SUCTION PORT.

FITTING HAS INTEGRAL VALVE CORE - ORIGINAL CORE IS REMOVED
 PRIOR TO FITMENT.

(INCLUDES COS-80841 CAP)

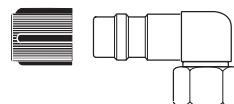

COS-96888 (single)
COS-96888-6 (pack of 6)

90 DEGREE STEEL ACCESS VALVE ADAPTOR

CONVERTS STANDARD R-12 1/4" MF
 ACCESS TO R134a SUCTION PORT.

FITTING HAS INTEGRAL VALVE CORE - ORIGINAL CORE IS REMOVED
 PRIOR TO FITMENT.

(INCLUDES COS-80841 CAP)

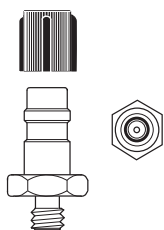
Compressor R134a Low Side**Sanden**

COS-96890

R134a SUCTION (LOW SIDE) ACCESS VALVE ADAPTOR

SCREWS DIRECTLY INTO SANDEN COMPRESSOR HEAD
 AND REPLACES ORIGINAL R-12 ACCESS PORT.

FITTING HAS INTEGRAL VALVE CORE.

(INCLUDES COS-80845 CAP)

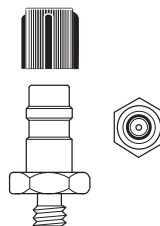
Seiko-Seiki

COS-96892

R134a SUCTION (LOW SIDE) ACCESS VALVE ADAPTOR

SCREWS DIRECTLY INTO SEIKO-SEIKI COMPRESSOR HEAD
 AND REPLACES ORIGINAL R-12 ACCESS PORT.

FITTING HAS INTEGRAL VALVE CORE.

(INCLUDES COS-80845 CAP)

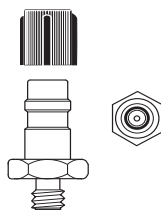
TX Valve R134a High Side

COS-96905

R134a DISCHARGE (HIGH SIDE) ACCESS VALVE ADAPTOR

SCREWS INTO TX VALVES WITH ACCESS PORTS SUCH
 AS SOME FORD FALCON VALVES.

FITTING HAS INTEGRAL VALVE CORE.

(INCLUDES COS-80841 CAP)

Compressor Spares: Service Valves

SERVICE VALVES: FITTING TYPES

Fitting Identification

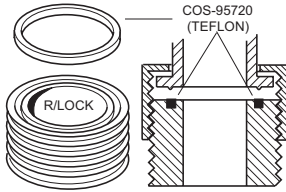
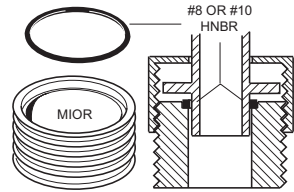
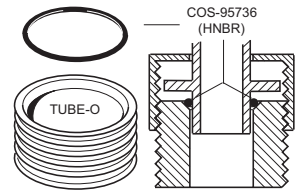
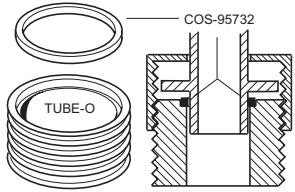
 <p>ROTOLOCK FITTING COMMON FITTING ON TECUMSEH AND YORK RECIPROCATING COMPRESSORS AND SOME SANDEN MODELS. (USE COS-95720 SQUARE CUT TEFLON O-RING)</p>	 <p>FEMALE O-RING (FOR) CAN BE USED ON SANDEN AND OTHER COMPRESSORS WITH MIOR FITTINGS TO ENABLE THE USE OF SERVICE VALVES. (USE APPROPRIATE #8 OR #10 HOSE FITTING O-RING)</p>	 <p>YORK TUBE - O COMMON FITTING ON SOME OEM WITH YORK COMPRESSORS. (USE COS-95736 HNBR O-RING)</p>	 <p>SANDEN TUBE - O USED ON SOME SANDEN COMPRESSORS TO ENABLE THE USE OF SERVICE VALVES. (USE COS-95732 O-RING)</p>
---	---	--	---

SERVICE VALVES: R12

Flange to Flare: R12

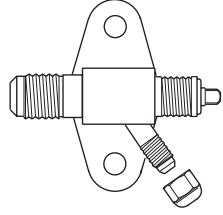
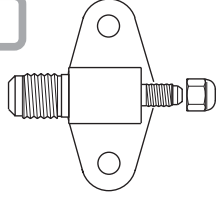
 <p>FLANGE TO FLARE (MF) BACK-SEAT TYPE</p> <p>COS-97248 - No. 8 COS-97250 - No. 10</p>	 <p>FLANGE TO FLARE (MF) SCHRADER TYPE</p> <p>COS-97280 - No. 8 COS-97285 - No. 10 (NLA - use COS-97250)</p>
---	--

RotoLock to Flare

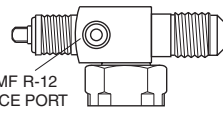

1/4" MF R-12 SERVICE PORT

ROTOLOCK TO FLARE (MF)
BACK-SEAT TYPE

COS-97453 - No. 8
COS-97458 - No. 10

RotoLock to O-Ring

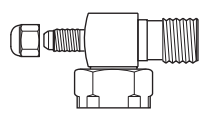
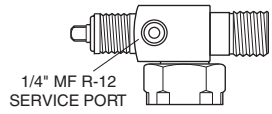
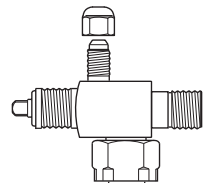
 <p>ROTOLOCK TO O-RING (MIOR) SCHRADER TYPE</p> <p>COS-97558 - No. 8 COS-97560 - No. 10</p>	 <p>1/4" MF R-12 SERVICE PORT</p> <p>ROTOLOCK TO O-RING (MIOR) BACK-SEAT TYPE</p> <p>COS-97610 - No. 8 COS-97615 - No. 10</p>	 <p>ROTOLOCK TO O-RING (MIOR) BACK-SEAT TYPE</p> <p>COS-97618 - No. 8 COS-97620 - No. 10</p>
--	---	---

Tube-O to Flare

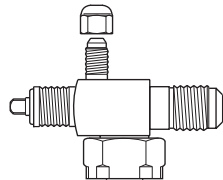

TUBE-O TO FLARE (MF) BACK-SEAT TYPE

COS-97668 - No. 8
COS-97670 - No. 10

Tube-O to O-Ring

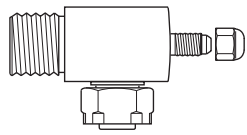

TUBE-O TO O-RING (MIOR) SCHRADER TYPE

COS-97728 - No. 8
COS-97730 - No. 10

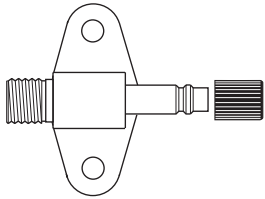
Compressor Spares: Service Valves**SERVICE VALVES: R134a****Flange to MIOR**

FLANGE TO O-RING (MIOR) WITH R134a ACCESS
STANDARD VALVE TYPE

COS-98008 - No. 8
COS-98010 - No. 10

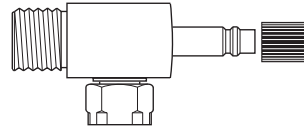
Female O-Ring to MIOR

FEMALE O-RING (FOR) TO O-RING (MIOR)
WITH R134a ACCESS
STANDARD VALVE TYPE

COS-98028 - No. 8
COS-98030 - No. 10

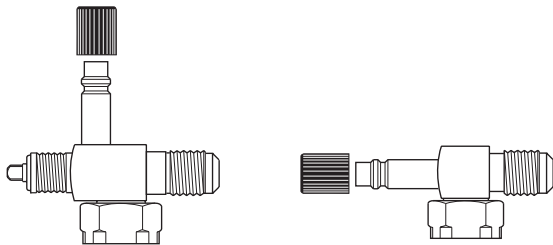
Rotolock to Flare

ROTOLOCK TO FLARE (MF)
WITH R134a ACCESS
BACK-SEAT TYPE

COS-98058 - No. 8
COS-98060 - No. 10

ROTOLOCK TO FLARE (MF)
WITH R134a ACCESS
STANDARD VALVE TYPE

COS-98078 - No. 8
COS-98080 - No. 10

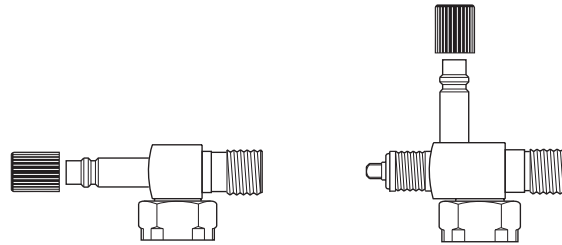
Rotolock to MIOR

ROTOLOCK TO O-RING (MIOR)
WITH R134a ACCESS
STANDARD VALVE TYPE

COS-98098 - No. 8
COS-98100 - No. 10

ROTOLOCK TO O-RING (MIOR)
WITH R134a ACCESS
BACK-SEAT TYPE

COS-98118 - No. 8
COS-98120 - No. 10

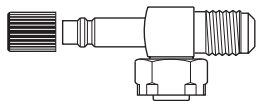
Tube-O to Flare

TUBE-O TO MALE FLARE (MF)
WITH R134a ACCESS
STANDARD VALVE TYPE

COS-98138 - No. 8
COS-98140 - No. 10

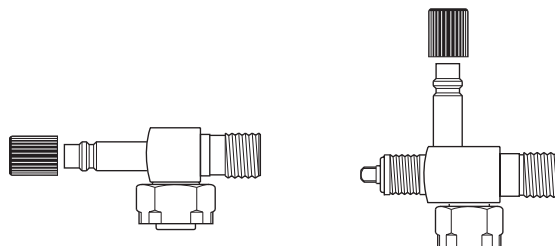
Tube-O to MIOR

TUBE-O TO O-RING (MIOR)
WITH R134a ACCESS
STANDARD VALVE TYPE

COS-98158 - No. 8
COS-98160 - No. 10

TUBE-O TO O-RING (MIOR)
WITH R134a ACCESS
BACK-SEAT TYPE

COS-98178 - No. 8
COS-98180 - No. 10

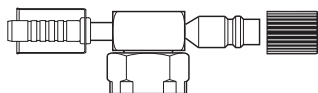
Rotolock to Beadlock

ROTOLOCK TO BEADLOCK
WITH R134a ACCESS
STANDARD VALVE TYPE

COS-98358 - No. 8
COS-98360 - No. 10

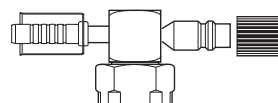
Tube-O to Beadlock

TUBE-O TO BEADLOCK
WITH R134a ACCESS
STANDARD VALVE TYPE

COS-98448 - No. 8
COS-98450 - No. 10