



# TOOLS & EQUIPMENT

## QUICK - REFERENCE GUIDE

| ITEM                                       | DETAILS   | PAGE      |
|--|---|-----------|
| <b>CHARGING &amp; RECOVERY EQUIPMENT :</b> |   |           |
| -  | CHARGING, RECOVERY, RECYCLING, MULTI-FUNCTION STATIONS .....  | 390 - 391 |
| -  | CHARGING CYLINDERS ("DIAL - A - CHARGE" CYLINDERS) .....      | 391       |
| -  | MANIFOLD TEST GAUGES, LINES, MANIFOLD SPARES .....            | 393 - 395 |
| -  | SCALES, REFRIGERANT WEIGHING .....                            | 392       |
| -  | VACUUM PUMPS AND SPARES .....                                 | 392 - 393 |
| <b>LEAK DETECTION :</b>                    |   |           |
| -  | ELECTRONIC LEAK DETECTORS .....                               | 396 - 397 |
| -  | ULTRA - VIOLET LEAK DETECTORS .....                           | 398 - 399 |
| <b>TEST EQUIPMENT :</b>                    |   |           |
| -  | REFRIGERANT ANALYSERS .....                                   | 399       |
| -  | THERMOMETERS: POCKET, DIGITAL, THERMO-COUPLE, INFRA-RED ..... | 400       |
| <b>GENERAL TOOLS AND SERVICE ITEMS :</b>   |   |           |
| -  | ACCESS FITTINGS, COUPLERS, SPARES .....                       | 395       |
| -  | COMPRESSOR REPAIR .....                                       | 407 - 408 |
| -  | CYLINDERS: REFRIGERANT, REFRIGERANT RECOVERY .....            | 401       |
| -  | DYE: LEAK DETECTION .....                                     | 398       |
| -  | FLUSHING & FLUSH RECOVERY EQUIPMENT, FLUSH SOLVENT .....      | 402       |
| -  | GAUGES: MANIFOLD SETS .....                                   | 393       |
| -  | GAUGES: VACUUM TESTING .....                                  | 402       |
| -  | HOSE CRIMPING TOOLS .....                                     | 404 - 405 |
| -  | INJECTORS, OIL .....  | 403       |
| -  | INSPECTION TOOL, FIBRE OPTIC .....                            | 404       |
| -  | O-RINGS: ACCESS VALVES AND COUPLERS .....                     | 395       |
| -  | O-RINGS: MANIFOLD AND VALVE REPAIR .....                      | 394       |
| -  | ORIFICE REMOVAL, CORE REMOVAL TOOLS .....                     | 406       |
| -  | SEALANTS, SYSTEM SEALANT .....                                | 403       |
| -  | SPRINGLOCK REPAIR TOOLS .....                                 | 406       |
| -  | UNIONS: CYLINDER, MANIFOLD, VACUUM PUMP .....                 | 407       |
| -  | WRENCHES: SERVICE VALVE .....                                 | 406       |

**Charging and Recovery Equipment**

**CHARGING STATIONS**



R12 & R134a connections included

Swiss manifold, gauges and 2 - stage vacuum pump

**TO-73210  
AIR-CHIEF  
DIGITAL CHARGING STATION**

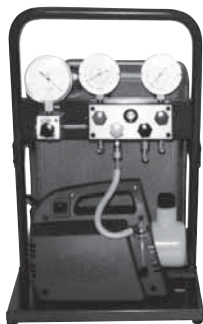

**TO-73215  
REFCO HAND - CARRY  
DIGITAL CHARGING STATION**



**ROBINAIR  
DIGITAL CHARGING STATION  
2-STAGE VACUUM PUMP**

TO-73207: 28 lpm vacuum pump  
TO-73208: 94 lpm vacuum pump

Digital scales allow charging with specified amounts of refrigerant accurately.

**RECOVERY STATIONS**

**CPS**



**TO-73270 - CR300E  
RECOVERY STATION  
OIL-FILLED COMPRESSOR**



**TO-73272 CR500E  
TO-73277 AR500E**



**RECOVERY ONLY  
RECOVERY / RECYCLE  
OIL-LESS COMPRESSOR**

**Robinair**



**ROBINAIR  
RECOVERY STATION  
(LIMITED STOCK)**



**ROBINAIR MINIMAX-E RECOVERY STATION  
TO-73250 RECOVERY ONLY  
TO-73253 RECOVERY ONLY with oil separator  
TO-73257 RECOVERY WITH RECYCLE KIT**

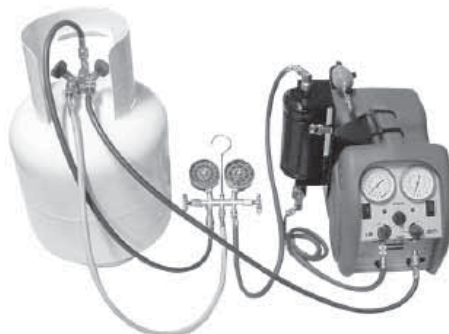

**TO-73430  
ROBINAIR RECYCLE UNIT  
CAN BE USED IN CONJUNCTION  
WITH MOST ROBINAIR RECOVERY  
STATIONS.  
(TO-73257 ILLUSTRATED)**

**NOTE:** All current model Robinair Recovery Stations have oil-less compressors

## Charging and Recovery Equipment

## RECOVERY-RECYCLE-RECHARGE STATIONS



**TO-73324**  
**ROBINAIR AC350-2K**

**4 in 1 SEMI-AUTOMATIC  
UNIT WITH BUILT IN  
GAUGES**



**TO-73335**  
**ROBINAIR 34701-2K**

**FULLY AUTOMATIC UNIT  
WITH INTERNAL SCALES  
AND TANK**

## Station Replacement Parts

| PART No. | ITEM              | TYPE / APPLICATION    | STATION  | OEM APPLICATION DETAILS |
|----------|-------------------|-----------------------|----------|-------------------------|
| TO-18830 | COMPRESSOR        | RECLAIM, 1/3 hp       | TO-73242 | ROBINAIR No. RA17411    |
| TO-28385 | FILTER            | RECYCLING             | TO-73255 | ROBINAIR No. 17130      |
| TO-28392 | FILTER            | RECYCLING             | TO-73295 | ROBINAIR No. 17430      |
| TO-28410 | FILTER            | RECYCLING             | TO-73390 | ROBINAIR No. 34430      |
| TO-28417 | FILTER            | RECYCLING             | TO-73422 | ROBINAIR No. 17678      |
| TO-31495 | GASKET (set of 2) | LIQUID RECYCLING PUMP |          | ROBINAIR No. RA17068    |
| TO-73650 | SWITCH, POWER     | RECLAIM UNIT          |          | ROBINAIR No. RA17135    |
| TO-73680 | SWITCH, POWER     | RECLAIM UNIT          |          | ROBINAIR No. RA17138    |
| TO-73720 | SWITCH, PRESSURE  | RECLAIM UNIT          |          | ROBINAIR No. RA17072    |
| TO-73750 | SWITCH, VACUUM    | RECLAIM UNIT          |          | ROBINAIR No. RA18752    |
| TO-81200 | WHEEL             | STATION               | TO-73210 | AIR-CHIEF               |

## CHARGING CYLINDERS

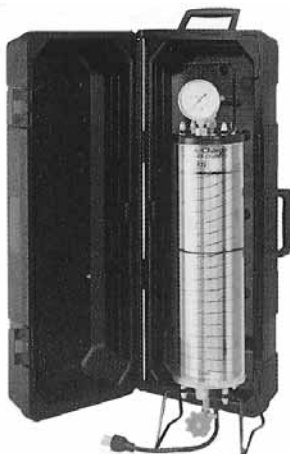

**TO-18350**  
**ROBINAIR 34205A**  
**2200 gram (5 lb)**

**TO-18355**  
**REFCO**  
**4000 gram (10 lb)**



## Charging Cylinder Replacement Parts

| PART No. | ITEM   | TYPE / APPLICATION | STATION            | OEM APPLICATION / DETAILS |
|----------|--|--------------------|--------------------|---------------------------|
| TO-18328 | CASING, CALIBRATED   | CHARGING CYLINDER  | REFCO 4000 gram    | REFCO SUITS TO-18355      |
| TO-18334 | CASING, CALIBRATED   | CHARGING CYLINDER  | ROBINAIR 4400 gram | ROBINAIR 113125           |
| TO-31322 | GASKET KIT   | CHARGING CYLINDER  | REFCO 4000 gram    | REFCO                     |
| TO-31350 | GASKET KIT   | CHARGING CYLINDER  | ROBINAIR 2200 gram | ROBINAIR 43699            |
| TO-31370 | GASKET KIT   | CHARGING CYLINDER  | ROBINAIR 4400 gram | ROBINAIR 10748RA          |
| TO-31785 | GAUGE, R12 / R134a<br>NOTE: TO-31785 REPLACES ORIGINAL TO-31850 AND TO-31854 R12 GAUGES AND DOES R12 & R134a | CHARGING CYLINDER  | REFCO 4400 gram    | SUITS REFCO AND ROBINAIR  |
| TO-70700 | SIGHT GLASS  | CHARGING CYLINDER  | ROBINAIR 4400 gram | ROBINAIR 43291            |

**Charging and Recovery Equipment**

**REFRIGERANT WEIGHING SCALES**



**TO-69110  
AIR-CHIEF  
ELECTRONIC  
WEIGHING SCALES**

- 50 kg total capacity (including cylinder)
- remote read-out
- 20 gram increments,
- battery operated (TO-15184 supplied)



view of TO-69110 scale head showing transformer plug provision



**TO-15184**  
9 volt battery for scale head



**TO-61344**  
**OPTIONAL POWER PACK**  
(9-Volt) for TO-69110



**TO-69302  
ROBINAIR  
ELECTRONIC  
WEIGHING SCALES**

- 100 kg total capacity (including cylinder)
- remote read-out
- 4 gram increments
- Charging and Recovery Capabilities



**TO-69306  
ROBINAIR  
PROGRAMMABLE  
CHARGING / RECOVERY  
METER**

- 100 kg total capacity (including cylinder)
- remote read-out
- 4 gram increments
- Automatic Charging and Recovery Operations

**VACUUM PUMPS**



**TO-62190  
JAVAC MINIVAC - 2  
VACUUM PUMP  
2-STAGE**



**TO-62234  
REFCO VACUUM PUMP  
30 lpm 2-STAGE  
(discontinued, replaced by  
TO-62260)**



**TO-62260  
REFCO VACUUM PUMP  
35 lpm 2-STAGE**



**TO-62265  
REFCO VACUUM PUMP  
65 lpm 2-STAGE**



**TO-62297  
REFCO VACUUM PUMP  
150 lpm 2-STAGE**



**ROBINAIR 28 lpm VACUUM PUMP  
TO-64028 28 lpm, SINGLE STAGE  
TO-64128 28 lpm, TWO STAGE**



**ROBINAIR 93 & 142 lpm VACUUM PUMPS  
TO-64194 93 lpm, TWO STAGE  
TO-64210 142 lpm, TWO STAGE**

**Charging and Recovery Equipment**

**VACUUM PUMPS . . . cont'd**

**Vacuum Pump Selection Guide**

| PART No. | BRAND    | MODEL     | MOTOR SIZE | CAPACITY (lpm) | VACUUM CAPABILITY | REFRIG. TYPE  | OTHER INFORMATION   |
|----------|----------|-----------|------------|----------------|-------------------|---------------|---------------------|
| TO-62190 | JAVAC    | MINIVAC-2 |            |                |                   | R-12 / R-134a | ROTARY, TWO - STAGE |
| TO-62260 | REFCO    | RL 2      | 1/5 HP     | 35             | 15 microns        | R-12 / R-134a | ROTARY, TWO - STAGE |
| TO-62265 | REFCO    | RL 4      | 1/4 HP     | 65             | 15 microns        | R-12 / R-134a | ROTARY, TWO - STAGE |
| TO-62297 | REFCO    | RL 8      | 1/2 HP     | 150            | 15 microns        | R-12 / R-134a | ROTARY, TWO - STAGE |
| TO-64028 | ROBINAIR | 34117     | 1/8 HP     | 28             | 50 microns        | R-12 / R-134a | DISCONTINUED        |
| TO-64128 | ROBINAIR | 15296     | 1/8 HP     | 28             | 50 microns        | R-12 / R-134a | ROTARY, TWO - STAGE |
| TO-64194 | ROBINAIR | 15444     | 1/3 HP     | 93             | 20 microns        | R-12 / R-134a | ROTARY, TWO - STAGE |
| TO-64210 | ROBINAIR | 15605     | 1/3 HP     | 142            | 20 microns        | R-12 / R-134a | ROTARY, TWO - STAGE |

NOTE: FOR THE PURPOSE OF EVACUATION OF AN AIR CONDITIONING SYSTEM, A VACUUM PUMP *MUST* BE CAPABLE OF PULLING A VACUUM OF 200 MICRONS OR LESS TO VAPORIZE AND EXTRACT MOISTURE AT NORMAL TEMPERATURES.

**Vacuum Pump Replacement Parts**

| ITEM                            | MAKE     | MODEL                             | PART No. |
|---------------------------------|----------|-----------------------------------|----------|
| BASE,                           | ROBINAIR | 15024, 15044, 15405, 15601, 15605 | TO-15120 |
| BASE,                           | ROBINAIR | 15113, 15117, 34117               | TO-15127 |
| HANDLE,                         | REFCO    | ROY-2                             | TO-33800 |
| HANDLE (INCLUDES SWITCH & CORD) | ROBINAIR | 15024, 15044, 15405, 15601, 15605 | TO-33805 |
| HANDLE                          | ROBINAIR | 15296                             | TO-33812 |
| JOINT, RUBBER FLEXIBLE DRIVE    | JAVAC    | DS40                              | TO-37300 |
| SIGHT GLASS                     | JAVAC    | DS40                              | TO-70950 |
| SIGHT GLASS                     | REFCO    | ROY-2                             | TO-70962 |
| SIGHT GLASS                     | ROBINAIR | 15117                             | TO-70975 |
| VANE (SET OF 6)                 | REFCO    | ROY-2                             | TO-79825 |
| VENT                            | ROBINAIR | 63117                             | TO-80010 |

**MANIFOLD GAUGE SETS**



REFCO FRONT WHEEL, 2-WAY, MULTI-REFRIGERANT MANIFOLD. SUPPLIED COMPLETE WITH 1830mm LINES AND R134a COUPLERS.

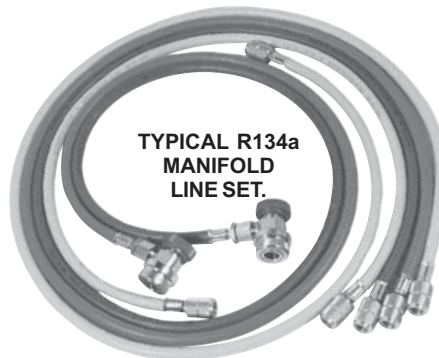

TYPICAL R134a MANIFOLD LINE SET.

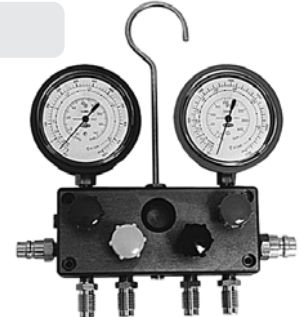

REFCO FRONT WHEEL, 4-WAY, MULTI-REFRIGERANT MANIFOLD. SUPPLIED COMPLETE WITH 1830mm LINES AND R134a COUPLERS.

**Manifold Selection Guide**

| PART No. | BRAND | COUPLERS.       | MANIFOLD TYPE | CHARGING LINES INCL. | SIGHT GLASS | OTHER INFORMATION                        |
|----------|-------|-----------------|---------------|----------------------|-------------|--|
| TO-51080 | REFCO | R134a, INCLUDED | FRONT WHEEL   | YES 1830 mm          | YES         | 2-WAY MANIFOLD; BELLWS GAUGES            |
| TO-51085 | REFCO | R134a, INCLUDED | FRONT WHEEL   | YES 1830 mm          | YES         | 4-WAY MANIFOLD; BELLWS GAUGES            |
| TO-51095 | REFCO | R134a, INCLUDED | FRONT WHEEL   | YES 1830 mm          | YES         | 4-WAY MANIFOLD WITH LIQUID FILLED GAUGES |

TYPICAL COMPOUND GAUGE



**Manifold Replacement Gauges**

TYPICAL PRESSURE GAUGE



| ITEM            | TYPE     | BRAND    | DIAL AND CALIBRATION | GAUGE TYPE   | PART No. |
|-----------------|----------|----------|----------------------|--------------|----------|
| GAUGE, MANIFOLD | COMPOUND | ROBINAIR | R12 DIAL Kpa / psi   | BOURDON TYPE | TO-31765 |
| GAUGE, MANIFOLD | COMPOUND | REFCO    | R134a DIAL Kpa / psi | BOURDON TYPE | TO-31783 |
| GAUGE, MANIFOLD | COMPOUND | REFCO    | R134a DIAL Kpa / psi | BELLWS TYPE  | TO-31785 |
| GAUGE, MANIFOLD | PRESSURE | ROBINAIR | R12 DIAL Kpa / psi   | BOURDON TYPE | TO-31820 |
| GAUGE, MANIFOLD | PRESSURE | REFCO    | R134a DIAL Kpa / psi | BOURDON TYPE | TO-31833 |
| GAUGE, MANIFOLD | PRESSURE | REFCO    | R134a DIAL Kpa / psi | BELLWS TYPE  | TO-31835 |

## Manifold - Test Gauge Sets and Spares

### MANIFOLD GAUGE SPARES



TO-34010  
HANDWHEEL SET



TO-34025  
HANDWHEEL SET

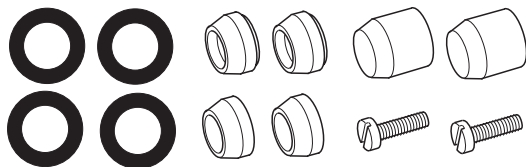

TO-70480  
ROBINAIR MANIFOLD SEAL KIT.  
(INCLUDES NYLON SEALS AND SEATS)



TO-73500  
ROBINAIR  
MANIFOLD STEM

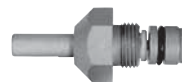

TO-73501  
REFCO  
MANIFOLD STEM

### Manifold Replacement Parts

| ITEM                         | MODEL APPLICATION AND OTHER INFORMATION | PART No.   |
|------------------------------|---|------------|
| HANDWHEEL                    | CPS - MOST MODELS                       | 1 ONLY     |
| HANDWHEEL                    | REFCO - ALL MODELS                      | (SET OF 4) |
| HANDWHEEL                    | ROBINAIR - MOST MODELS                  | (SET OF 2) |
| SEAL KIT, MANIFOLD           | CPS - SUITS MOST CPS                    | MANIFOLDS  |
| SEAL KIT, MANIFOLD           | ROBINAIR - SUITS MOST ROBINAIR          | MANIFOLDS  |
| SEAL KIT, MANIFOLD AND LINES | ROBINAIR - SUITS MOST ROBINAIR          | MANIFOLDS  |
| SIGHT GLASS                  | REFCO - SUITS MOST REFCO                | MANIFOLDS  |
| STEM, MANIFOLD VALVE REPAIR  | ROBINAIR - SUITS MOST ROBINAIR          | MANIFOLDS  |
| STEM, MANIFOLD VALVE REPAIR  | REFCO - SUITS MOST REFCO                | MANIFOLDS  |
|                              |   | TO-34004   |
|                              |   | TO-34010   |
|                              |   | TO-34025   |
|                              |   | TO-70468   |
|                              |   | TO-70480   |
|                              |   | TO-70500   |
|                              |   | TO-70940   |
|                              |   | TO-73500   |
|                              |   | TO-73501   |

### MANIFOLD CHARGING LINES



TYPICAL 14"  
STANDARD  
CHARGING  
LINE

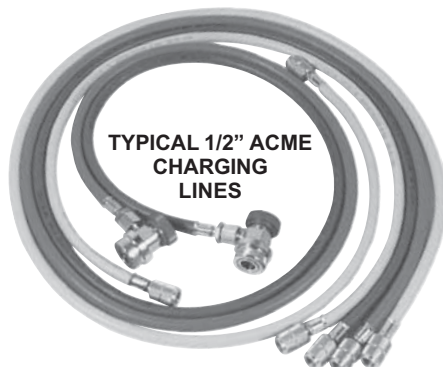

TYPICAL 1/2" ACME  
CHARGING  
LINES



TYPICAL 1/4"  
QUICKSEAL  
CHARGING  
LINE

NOTE: COUPLERS ARE NOT INCLUDED

| PART No.  | TYPE       | COLOUR | LENGTH  | FITTINGS         | MANUFACTURER |
|-----------|------------|--------|---------|------------------|--------------|
| TO-40212  | STANDARD   | BLUE   | 300 mm  | 1/4" - 1/4"      | AIR-CHIEF    |
| TO-40312  | STANDARD   | RED    | 300 mm  | 1/4" - 1/4"      | AIR-CHIEF    |
| TO-42472  | STANDARD   | BLUE   | 1830 mm | 1/4" - 1/4"      | REFCO        |
| TO-42772  | STANDARD   | RED    | 1830 mm | 1/4" - 1/4"      | REFCO        |
| TO-42972  | STANDARD   | YELLOW | 1830 mm | 1/4" - 1/4"      | REFCO        |
| TO-43172  | QUICK-SEAL | BLUE   | 1830 mm | 1/4" - 1/4"      | ROBINAIR     |
| TO-43272  | QUICK-SEAL | RED    | 1830 mm | 1/4" - 1/4"      | ROBINAIR     |
| TO-43372  | QUICK-SEAL | YELLOW | 1830 mm | 1/4" - 1/4"      | ROBINAIR     |
| TO-47120  | STANDARD   | BLUE   | 3050 mm | 1/4" - 1/4"      | REFCO        |
| TO-48120  | STANDARD   | RED    | 3050 mm | 1/4" - 1/4"      | REFCO        |
| TO-49120  | STANDARD   | YELLOW | 3050 mm | 1/4" - 1/4"      | REFCO        |
| TO-49236Y | STANDARD   | YELLOW | 915 mm  | 1/4" - 1/2" ACME | REFCO        |
| TO-49372B |            | BLUE   | 1830 mm | ACME - M14       | REFCO        |
| TO-49372R |            | RED    | 1830 mm | ACME - M14       | REFCO        |
| TO-49372Y |            | YELLOW | 1830 mm | ACME - ACME      | REFCO        |
| TO-49420B |            | BLUE   | 3050 mm | ACME - M14       | REFCO        |
| TO-49420R |            | RED    | 3050 mm | ACME - M14       | REFCO        |
| TO-49420Y |            | YELLOW | 3050 mm | ACME - ACME      | REFCO        |

#### NOTES:

- LENGTHS OF CHARGING LINES ARE NOMINAL AND MAY VARY SLIGHTLY.
- ALL REFCO AND ROBINAIR CHARGING LINES ARE WARRANTED FOR 12 MONTHS AGAINST FAULTY MANUFACTURE AND ARE DESIGNED FOR WORKING PRESSURES UP TO 3,500 kpa (500 psi), WITH A BURST PRESSURE OF 17,500 kpa (2,500 psi).
- 1/4" LINES SUIT STANDARD 1/4" MF (7/16 - 20 UNF). ADAPTORS FOR 3/16" MF ACCESS VALVES ARE AVAILABLE.
- ACME LINES SUIT STANDARD 1/2" MALE ACME FITTINGS.

**Manifold - Test Gauge Sets and Spares**

**R12 ACCESS ADAPTORS & COUPLERS**



**STANDARD STRAIGHT R-12 ACCESS COUPLERS**

- TO-12010 R-12 3/16" FF - 1/4" MF
- TO-12500 R-12 1/4" FF - 1/4" MF



**STANDARD 90 deg. R-12 ACCESS COUPLERS**

- TO-12090 R-12 3/16" FF - 1/4" MF
- TO-12590 R-12 1/4" FF - 1/4" MF



**ROBINAIR R-12 ANTI-BLOWBACK ACCESS COUPLERS**

- TO-13185 R-12 3/16" FF - 1/4" MF
- TO-13200 R-12 1/4" FF - 1/4" MF

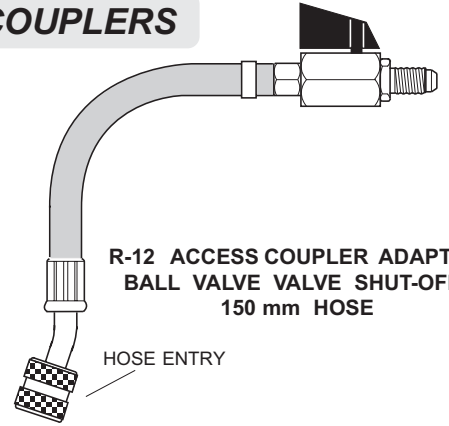

**R-12 ACCESS COUPLER ADAPTOR BALL VALVE SHUT-OFF, 150 mm HOSE**

HOSE ENTRY

- TO-13250 R-12 1/4" FF - 1/4" MF LOW SIDE (BLUE HOSE)
- TO-13255 R-12 1/4" FF - 1/4" MF HIGH SIDE (RED HOSE)

**R134a ACCESS ADAPTORS & COUPLERS**



**R134a ACCESS COUPLER COMPACT TYPE. HANDWHEEL OPERATION.**  
TO-14128 - DISCHARGE  
TO-14138 - SUCTION  
(Air - Chief)



**R134a ACCESS COUPLER COMPACT TYPE. HANDWHEEL OPERATION.**  
TO-14130 - DISCHARGE  
TO-14140 - SUCTION



**R134a 90 deg. ACCESS COUPLER COMPACT TYPE. HANDWHEEL OPERATION**  
TO-14134 - DISCHARGE  
TO-14236 - SUCTION



**TO-13284**  
R134a IN-LINE BALL VALVE  
1/2" MALE ACME - 1/2" FEM. ACME

**ACCESS ADAPTOR DEPRESSORS**

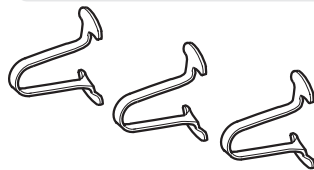

**R-12 ACCESS FITTING DEPRESSORS**

- TO-25050 - 3/16" (PACK OF 6)
- TO-25051 - 3/16" (PACK OF 10)
- TO-25150 - 1/4" (PACK OF 6)

**ACCESS ADAPTOR GASKETS & O-RINGS**



**TO-31050**  
EARLY ANTI-BLOWBACK SEAL - FLAT SECTION (DISCONTINUED)

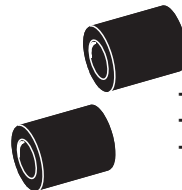

**R-12 ACCESS FITTING GASKETS**

- TO-31070 - 3/16" ROBINAIR (PACK OF 6)
- TO-31100 - 1/4" ROBINAIR (PACK OF 6)
- TO-31120 - 1/4" REFCO (PACK OF 10)



**TO-55900**  
REPLACEMENT O-RING FOR LATE TYPE TO-13185 (PACK OF 6)



**TO-55934**  
O-RING KIT FOR COUPLERS  
TO-14128, TO-14130, TO-14134  
TO-14138, TO-14140, TO-14136

NOTE: TO ASSIST IDENTIFICATION, THE O-RINGS ILLUSTRATED ABOVE ARE SHOWN ACTUAL SIZE.

**Leak Detection Equipment****ELECTRONIC LEAK DETECTORS****TO-25265  
CPS - L780B Leak - Seeker**

SUITABLE FOR R134a, R-12, MOST CFC'S & HCFC'S

SENSITIVITY: 7 grams (1/4 oz) PER YEAR

**FEATURES:**

- INSTANT RESPONSE
- AUDIBLE ALARM PLUS VISUAL RED INDICATOR
- BUILT IN SUCTION PUMP
- VISUAL INDICATOR SHOWS REFRIGERANT CONCENTRATION
- LOW BATTERY INDICATOR
- AMBIENT CONDITION BALANCE ADJUSTMENT
- ADJUSTABLE SENSITIVITY
- FLEXIBLE PROBE
- DESIGNED TO SAE J1627 SPECIFICATIONS

**REPLACEMENT PARTS**

SENSING ELEMENT - TO-28180  
SENSING ELEMENT COVER - TO-75350

**TO-25270  
CPS - L790B Leak-Seeker**

SUITABLE FOR R134a, R-12, MOST CFC'S AND HCFC'S

SENSITIVITY: 3 grams (1/10 oz) PER YEAR

**FEATURES:**

- INSTANT RESPONSE
- AUDIBLE ALARM, VISUAL RED INDICATOR (EITHER OR BOTH CAN BE SELECTED)
- VISUAL INDICATOR SHOWS REFRIGERANT CONCENTRATION
- BUILT IN SUCTION PUMP
- LOW BATTERY INDICATOR
- ADJUSTABLE SENSITIVITY
- AMBIENT CONDITION BALANCE ADJUSTMENT
- FLEXIBLE PROBE
- AUTOMATICALLY SWITCHES OFF WHEN NOT IN USE
- EARPHONE INCLUDED
- DESIGNED TO SAE J1627 SPECIFICATIONS

**REPLACEMENT PARTS;**

SENSING ELEMENT - TO-28180  
SENSING ELEMENT COVER - TO-75350

**TO-25285  
CPS - LS3000**

SUITABLE FOR R134a, R-12, MOST CFC'S AND HCFC'S

SENSITIVITY: 3 grams (1/10 oz) PER YEAR

**FEATURES:**

- INSTANT RESPONSE
- AUDIBLE HIGH OUTPUT ALARM WITH TONE CHANGE FUNCTION
- UNIQUE SELECTIVE FILTER DESIGN GIVES EXCELLENT RESISTANCE TO BACKGROUND CONTAMINANTS LIKE OIL AND COOLANT.
- VISUAL INDICATOR SHOWS REFRIGERANT CONCENTRATION IN "TACHOMETER" STYLE DISPLAY
- LONG BATTERY LIFE ON STANDARD 'C' SIZE BATTERIES
- FULLY AUTOMATIC GAIN SELECTION
- RESET FUNCTION
- UNIQUE "GEAR SHIFT" STYLE LEAK SIZE INDICATOR
- FLEXIBLE PROBE
- DESIGNED TO SAE J1627 SPECIFICATIONS

**REPLACEMENT PARTS;**

SENSING ELEMENT - TO-75353

**IMPORTANT NOTE:**

**ELECTRONIC DETECTORS MUST NOT BE USED WITH FLAMMABLE SUBSTANCES**  
MOST ELECTRONIC LEAK DETECTORS DESIGNED FOR CFC'S AND R134a USE A HIGH TENSION SPARK IN THE SENSING TIP AND MUST NEVER BE USED TO DETECT FLAMMABLE SUBSTANCES SUCH AS LPG.



## Leak Detection Equipment

## ELECTRONIC LEAK DETECTORS



**TO-25374**  
Model 5650A

SUITABLE FOR R134a, R-12, MOST CFC'S & HCFC'S

SENSITIVITY: 7 grams (1/4 oz) PER YEAR

**FEATURES:**

- INSTANT RESPONSE
- AUDIBLE ALARM PLUS VISUAL RED INDICATOR
- BUILT IN SUCTION PUMP
- VISUAL INDICATOR SHOWS REFRIGERANT CONCENTRATION
- LOW BATTERY INDICATOR
- AMBIENT CONDITION BALANCE ADJUSTMENT
- ADJUSTABLE SENSITIVITY
- FLEXIBLE PROBE
- DESIGNED TO SAE J1627 SPECIFICATIONS

**REPLACEMENT PARTS:** SENSING ELEMENT - TO-75364



**TO-25382**  
RX-1A High Tech

SUITABLE FOR R134a, R-12, MOST CFC'S & HCFC'S

SENSITIVITY: 7 grams (1/4 oz) PER YEAR

**FEATURES:**

- ADVANCED DIGITAL SIGNAL PROCESSOR
- 2 SENSITIVITY LEVELS
- INSTANT RESPONSE
- VERY STABLE AND RELIABLE
- AUDIBLE ALARM PLUS VISUAL RED BAR-GRAPH INDICATOR
- BUILT IN SUCTION PUMP
- VISUAL INDICATOR SHOWS REFRIGERANT CONCENTRATION
- LOW BATTERY INDICATOR
- ADJUSTABLE SENSITIVITY
- ONE TOUCH RESET AND KEYPAD CONTROLS
- FLEXIBLE STAINLESS STEEL PROBE
- DESIGNED TO SAE J1627 SPECIFICATIONS
- INCLUDES HEAVY DUTY CARRY CASE

**REPLACEMENT PARTS:** SENSING ELEMENT - TO-75364



**TO-25388**  
XP-1A High Performance

SUITABLE FOR R134a, R-12, MOST CFC'S & HCFC'S

SENSITIVITY: 3 grams (0.1 oz) PER YEAR

**FEATURES:**

- ADVANCED DIGITAL SIGNAL PROCESSOR
- INSTANT RESPONSE
- 7 SENSITIVITY LEVELS
- AUDIBLE ALARM PLUS VISUAL TRI-COLOUR INDICATOR WITH 18 LEVELS FOR CLEAR INDICATION OF LEAK SIZE
- BUILT IN SUCTION PUMP
- BATTERY VOLTAGE TEST / INDICATOR
- 7 LEVELS OF SENSITIVITY
- 1 TOUCH RESET AND KEYPAD CONTROLS
- FLEXIBLE STAINLESS STEEL PROBE
- DESIGNED TO SAE J1627 SPECIFICATIONS
- HEAVY DUTY CARRY CASE INCLUDED

**REPLACEMENT PARTS:** SENSING ELEMENT - TO-75364



**TO-25442**  
ZX-1A Heated Pentode

SUITABLE FOR R134a, R-12, MOST CFC'S & HCFC'S

SENSITIVITY: 3 grams (0.1 oz) PER YEAR

**FEATURES:**

- HEATED PENTODE OPERATION :
  - REFRIGERANT SPECIFIC DETECTION
  - ELIMINATION OF FALSE ALARMS
  - UNAFFECTED BY RAPID TEMPERATURE CHANGE
- INSTANT RESPONSE
- AUDIBLE ALARM PLUS VISUAL TRI-COLOUR INDICATOR
- BUILT IN SUCTION PUMP
- BATTERY VOLTAGE TEST / INDICATOR
- AMBIENT CONDITION BALANCE ADJUSTMENT
- 2 LEVELS OF SENSITIVITY
- 1 TOUCH RESET AND KEYPAD CONTROLS
- FLEXIBLE STAINLESS STEEL PROBE
- DESIGNED TO SAE J1627 SPECIFICATIONS
- HEAVY DUTY CARRY CASE INCLUDED

**REPLACEMENT PARTS:** SENSING ELEMENT - TO-75387

**IMPORTANT NOTE:**

**ELECTRONIC DETECTORS MUST NOT BE USED WITH FLAMMABLE SUBSTANCES**

MOST ELECTRONIC LEAK DETECTORS DESIGNED FOR CFC'S AND R134a USE A HIGH TENSION SPARK IN THE SENSING TIP AND MUST NEVER BE USED TO DETECT FLAMMABLE SUBSTANCES SUCH AS LPG.

## Leak Detection Equipment

### ULTRA - VIOLET LEAK DETECTORS

#### Glo-Leak Ultra Violet Leak Detection System



**TO-25658**  
**MODULAR POCKET LAMP**  
**WITH FLEXIBLE EXTENSION**  
 (includes one 5 UVA diode head, order 5-diode white or MagniFocus4 heads separately if required)

#### GLO-LEAK THE VERSATILE LEAK DETECTION SYSTEM.

For use with most fluid leaks, including Air Conditioning, Refrigeration, Hydraulics, Cooling Systems and Fuel Systems.

|                 |          |          |   |                                 |
|-----------------|----------|----------|---|---------------------------------|
| <b>TO-25658</b> | GLO-LEAK | POCKET   | ULTRA-VIOLET LAMP KIT IN MOULDED CARRY CASE | POCKET TYPE WITH FLEXIBLE PROBE |
| <b>TO-25665</b> | GLO-LEAK | 12 volt  | ULTRA-VIOLET LAMP KIT IN MOULDED CARRY CASE | 12v ONLY                        |
| <b>TO-25675</b> | GLO-LEAK | 240 volt | ULTRA-VIOLET LAMP KIT IN METAL CARRY CASE   | 240v ONLY                       |

LAMP KITS INCLUDE SAFETY GLASSES (TO-32100)

#### Ultra-Violet Lamp Replacement Parts

| PART No.        | ITEM                  | TYPE           | LAMP     | APPLICATION / DETAILS       |
|-----------------|-----------------------|----------------|----------|-----------------------------|
| <b>TO-28460</b> | FILTER LENS           | U - V (BLACK)  | TO-25675 | 240 VOLT LAMP               |
| <b>TO-28485</b> | FILTER LENS           | U - V (BLACK)  | TO-25665 | 12 VOLT LAMP                |
| <b>TO-28500</b> | FILTER LENS           | U - V (BLUE)   | TO-25665 | 12 VOLT LAMP                |
| <b>TO-31940</b> | GLOBE                 | U - V 100 WATT | TO-25665 | 12 VOLT LAMP                |
| <b>TO-31960</b> | GLOBE                 | U - V 100 WATT | TO-25675 | 240 VOLT LAMP               |
| <b>TO-32100</b> | GOGGLES               | SAFETY, U - V  | N - A    | USE TO ENHANCE FLUORESCENCE |
| <b>TO-33774</b> | HANDLE                | U - V LAMP     | TO-25675 | SUITS LATE TYPE LAMP        |
| <b>TO-34061</b> | HEAD, 5 - DIODE UVA   | U - V LAMP     | TO-25658 | SUITS MODULAR POCKET LAMP   |
| <b>TO-34063</b> | HEAD, 5 - DIODE WHITE | U - V LAMP     | TO-25658 | SUITS MODULAR POCKET LAMP   |
| <b>TO-34065</b> | HEAD, MAGNI FOCUS 4   | U - V LAMP     | TO-25658 | SUITS MODULAR POCKET LAMP   |

#### Glo-Leak U-V Dye Selection Guide

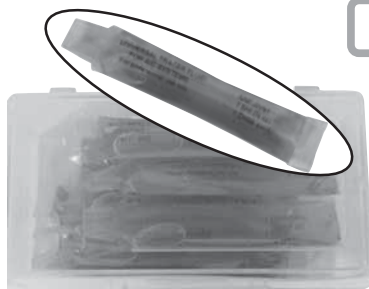

**TO-27412**  
 Sachet - 12-shot pack  
 (pack of 12 7.5ml sachets)



**TO-27441**  
 Cartridge, for use with  
 TO-36115 injector



**TO-27455**  
 100 ml bottle, for use with  
 TO-36100 injector



**TO-27583, TO-27600,  
 TO-27650, TO-27700,  
 TO-27760**  
 250 ml Bottle

#### 1. Air Conditioning and Refrigeration Dye.

| PART No.        | FORMULA     | PACK / CONTAINER TYPE       | No. OF INJECTIONS     | APPLICATION / COMPATABILITY REFRIGERANT | COMPATABILITY LUBRICANT |
|-----------------|-------------|-----------------------------|-----------------------|---|-------------------------|
| <b>TO-27412</b> | CONCENTRATE | 12 SACHETS ( 7.5ml )        | 12 - SHOT             | R12, R134a                              | MINERAL / ESTER / PAG   |
| <b>TO-27441</b> | STANDARD    | CARTRIDGE                   | 12 / 24 - SHOT **     | R12, R134a                              | MINERAL / ESTER / PAG   |
| <b>TO-27444</b> | STANDARD    | CARTRIDGE (4-PACK)          | 4 x 12 / 24 - SHOT ** | R12, R134a                              | MINERAL / ESTER / PAG   |
| <b>TO-27452</b> | CONCENTRATE | 50 ml BOTTLE (PACK of 2)    |                       | R12, R134a                              | MINERAL / ESTER / PAG   |
| <b>TO-27455</b> | CONCENTRATE | 100 ml VIAL, SUITS TO-36100 |                       | R12, R134a                              | MINERAL / ESTER / PAG   |
| <b>TO-27583</b> | STANDARD    | 250 ml PLASTIC BOTTLE       | 25 - SHOT             | R12, R134a                              | MINERAL / ESTER / PAG   |
| <b>TO-27600</b> | CONCENTRATE | 250 ml PLASTIC BOTTLE       | 80 - SHOT             | R12, R134a                              | MINERAL / ESTER / PAG   |

\*\* INJECTION AMOUNT CAN BE VARIED ON TO-36115 INJECTION GUN

#### 2. Automotive / Industrial Dye.

|                 |                             |   |        |
|-----------------|-----------------------------|---|--------|
| <b>TO-27650</b> | DYE, AUTOMOTIVE             | TRANSMISSION                                | 250 ml |
| <b>TO-27700</b> | DYE, AUTOMOTIVE, INDUSTRIAL | ENGINE (RADIATOR) COOLANT                   | 250 ml |
| <b>TO-27760</b> | DYE, AUTOMOTIVE, INDUSTRIAL | ENGINE OIL, HYDRAULIC OIL AND FUEL SYSTEMS. | 250 ml |

FOR FURTHER INFORMATION, SPECIFICATIONS AND TECHNICAL DATA, PLEASE REFER TO THE LEAK DETECTION SECTION OF THE TECHNICAL GUIDE.

## Leak Detection Equipment

### ULTRA - VIOLET LEAK DETECTORS



**TO-36100**  
**INJECTOR GUN**

**REPLACEMENT PARTS:**

- TO-19850** FEMALE COUPLER  
**TO-22100** CALIBRATED CYLINDER  
**TO-38745** OVERHAUL KIT (INCLUDES CYLINDER)



**TO-36115**  
**INJECTOR GUN**

FOR USE WITH TO-27441 CARTRIDGE.

- HOSE (TO-34095) IS INCLUDED.
- COUPLER IS NOT INCLUDED - order TO-14236 if required

## Test Equipment

### REFRIGERANT ANALYSERS



**TO-26462**

REFRIGERANT DETECTOR.

THIS UNIT DETECTS AND IDENTIFIES:  
 CFC's, HFC's, HCFC's, FLAMMABLES, AND NON-CONDENSABLES.

THE CONTENTS OF THE SYSTEM OR CONTAINER ARE VISIBLE ON A DIGITAL READ-OUT, AND THE INFORMATION CAN BE PRINTED OUT ON MOST COMPUTER PRINTERS.

ONLY A SMALL AMOUNT OF REFRIGERANT IS REQUIRED AND IDENTIFICATION TAKES A FEW SECONDS.

**ACCESSORIES INCLUDED:**

- R12 and R134a CONNECTION
- BATTERY CLAMP ADAPTOR
- 12V CIGARETTE LIGHTER CORD
- IN-LINE FILTER
- OPERATOR'S MANUAL

REPLACEMENT FILTER: **TO-28439**



**FEATURES:**

- MICRO INFRARED SPECTROMETER DETECTION SYSTEM.
- ONE BUTTON TESTING WITH TEST RESULTS IN 3 - 5 SECONDS
- IDENTIFIES AND MEASURES THE PERCENTAGE (PURITY) OF THE REFRIGERANT, INCLUDING R134a, R12, R22, AND HYDROCARBONS.
- AUDIBLE AND VISUAL ALARMS WHERE FLAMMABLE HYDROCARBONS ARE PRESENT.
- INDICATES PRESENCE OF BLENDS AND CONTAMINATED REFRIGERANTS.
- INDICATES PRESENCE AND PERCENTAGE OF AIR IN THE SYSTEM.
- PRINTER PORT FOR RETENTION OF RECORDS - SUITS MOST PC PRINTERS.
- ALTITUDE COMPENSATION FEATURE ENSURES ACCURATE AIR MEASUREMENT.
- OPERATES ON 12 VOLT - OPTIONAL 240 VOLT ADAPTORS AVAILABLE.
- UL LISTED TO SAE J1771

**Test Equipment****DIAL and DIGITAL THERMOMETERS****TO-75090****DIAL TYPE THERMOMETER**

FLEXIBLE PROBE, 100 mm DIAL  
TEMPERATURE RANGE: -40 °C. to 40 °C.

**TO-75125**  
PROFESSIONAL DIGITAL THERMOMETER  
-40 °C. to 50 °C. (-40 °F. to 122 °F.)

- COMPACT, STEEL PROBE ON FLEXIBLE WIRE LEAD
- FOUR DIGIT DISPLAY ON DIGITAL READ-OUT
- DISPLAYS °C. OR °F
- FAST OR SLOW TEMPERATURE SENSING SPEED (1 OR 15 SECOND SAMPLING CYCLE)
- HIGH & LOW LIMIT TEMPERATURE SETTING FUNCTION

**TO-75100**

DIAL TYPE POCKET THERMOMETER  
METAL PROBE  
TEMP. RANGE: -40 °C. to 70 °C.

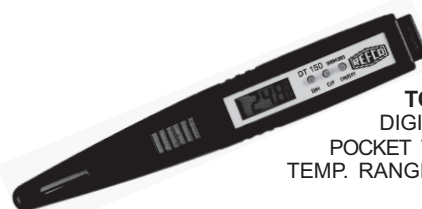
**TO-75121**

DIGITAL "PEN"  
POCKET THERMOMETER  
TEMP. RANGE: -50 °C. to 150 °C.

**THERMO-COUPLE THERMOMETER****TO-75158****THERMO-COUPLE THERMOMETER**

SUPPLIED COMPLETE WITH ONE THERMO-COUPLE PROBE,  
QUICK AND EASY TO USE - IDEAL FOR CHECKING  
SUPERHEAT AND SUB-COOLING.

AN ESSENTIAL TOOL FOR THE MODERN AIR CONDITIONING  
TECHNICIAN.

REPLACEMENT PROBE: **TO-61520****INFRA-RED THERMOMETERS****TO-75164****DELUXE INFRA-RED THERMOMETER****FEATURES:**

- LASER INDICATOR ENSURES TARGET ACCURACY
- PISTOL GRIP, EASY TO POINT
- INSTANT TEMPERATURE DISPLAY
- EASY TO READ BACK-LIT DIGITAL DISPLAY
- DISPLAYS °C. OR °F.
- LOW BATTERY INDICATOR
- TEMP. RANGE: -20 °C. to 500 °C.
- VIEW FIELD RATIO: 8 : 1

**TO-75175****INFRA-RED THERMOMETER****FEATURES:**

- LASER 8-POINT CIRCULAR INDICATOR ENSURES TARGET ACCURACY
- PISTOL GRIP, EASY TO POINT
- INSTANT TEMPERATURE DISPLAY
- EASY TO READ DIGITAL DISPLAY
- DISPLAYS °C. OR °F.
- CLEAR, BACK-LIT DIGITAL DISPLAY
- LOW BATTERY INDICATOR
- TEMP. RANGE: -32 °C. to 600 °C.
- HIGH - LOW ALARM
- VIEW FIELD RATIO: 30 : 1
- CARRY CASE INCLUDED

**General Tools and Service Items**

**BEAKER: OIL DRAIN**

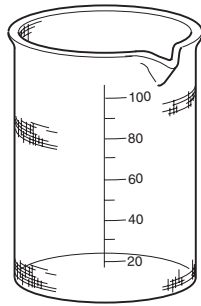

**TO-15300**  
100 ml GRADUATED BEAKER  
IDEAL FOR OIL MEASUREMENT ETC.

**CLEANER**



**TO-18375**  
500 ml ATOMISER  
GLO-KLENS BIODEGRADABLE CLEANER AND DEGREASER.  
A SAFE AND VERSATILE CLEANER, THIS PRODUCT IS NON-TOXIC TO HUMANS AND ANIMALS AND HELPS TO REMOVE TAR, WAXES, ADHESIVES, FRESH PAINT AND MANY OTHER HARD-TO-REMOVE SUBSTANCES.

IDEAL FOR CLEANING OFF GLO-LEAK TRACER DYES.

**COMB: FIN REPAIR**

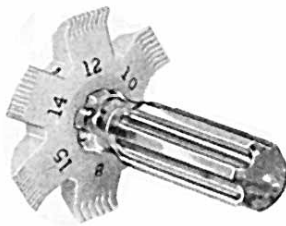

**TO-18740**  
FIN COMB  
MULTI-HEADED COMB SUITABLE FOR MOST CONDENSER AND EVAPORATOR FINS.

**CUTTER: HOSE**



**TO-21500**  
ATCO KWIK-CUT HOSE CUTTER  
CUTS ALL R-12 AND R134a REFRIGERANT HOSE QUICKLY AND EASILY.  
REPLACEMENT BLADE - TO-15500

**CYLINDERS**



| PART No. | CAPACITY | VALVE ARRANGEMENT                 |
|----------|----------|-----------------------------------|
| TO-22011 | 10 kg    | SINGLE VALVE                      |
| TO-22025 | 22 kg    | SINGLE VALVE, LIQUID PICK-UP TUBE |
| TO-22027 | 22 kg    | DUAL VALVES, SINGLE OUTLET        |
| TO-22044 | 25 kg    | DUAL VALVES, DUAL OUTLET          |

**DEODORANT**

CONCENTRATE IN 4" CAN MAKES IT PERFECT FOR THE GLOVE BOX



REDUCES AIR-BORNE BACTERIA

**TO-24900**  
HANDY SPRAY CAN (35 ml)  
THIS PRODUCT IS BIODEGRADABLE, AND HELPS TO PREVENT ODOURS AND MOULD IN THE EVAPORATOR COIL.  
GIVE THE CUSTOMER A CAN TO PREVENT ANY FURTHER PROBLEMS.

**General Tools and Service Items****FLUSHING EQUIPMENT****Flush Kit**

**TO-28760**  
AIR-CHIEF FLUSHING KIT  
INCLUDES CYLINDER, FLUSH GUN AND LINE  
FOR USE WITH TO-28724 FLUSHING SOLVENT.  
(FLUSHING SOLVENT IS NOT INCLUDED IN KIT)

**ACCESSORIES and PARTS**

ACCESS UNION FOR R134a **TO-14450**  
REPLACEMENT FLUSH GUN: **TO-32550**  
REPLACEMENT RUBBER TIP: **TO-75230**  
SPARE CAN FOR FLUSH: **TO-18160**

**TO-28724**

FLUSHING SOLVENT - 5 kg CAN

APPROVED FOR USE WITH R-12 AND R134a SYSTEMS.

WE DO NOT RECOMMEND ANY OTHER SOLVENT.  
MUST **NOT** BE USED WITH COMPRESSED AIR.

RECOMMENDED PROPELLANT IS NITROGEN.

**TO-66344**

NITROGEN REGULATOR  
(suits type 50 cylinders)

**TO-66555**

CONVERTER

(converts old type regulators  
to suit type 50 cylinders)

**TO-66344**

NITROGEN REGULATOR

AN ECONOMICAL NITROGEN REGULATOR, IDEAL FOR  
USE WITH FLUSHING KITS WHEN USING NITROGEN  
AS A PROPELLANT.

SCREW THE FLUSH KIT HOSE DIRECTLY ONTO THE  
REGULATOR.

AN APPROVED REGULATOR **MUST** BE USED WITH  
COMPRESSED NITROGEN AT ALL TIMES.

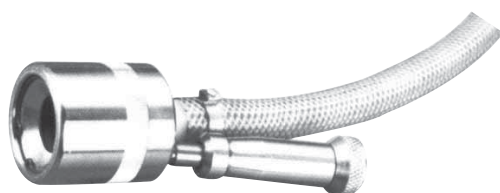
**Flush Recovery Unit****TO-28766**

AIR-CHIEF FLUSH RECOVERY UNIT

**CATCH AND REUSE SOLVENT !**

THIS SIMPLE, EFFECTIVE DEVICE ATTACHES  
TO FITTINGS WITHOUT TOOLS, USING A  
RUBBER MEMBRANE INFLATED BY A  
FINGER-SIZE PUMP.

**GAUGES, VACUUM TESTING****TO-31890**  
**REFCO**

DIGITAL VACUUM GAUGE

- reads in seven units:  
microns, PSI, in/Hg, mbar,  
Pascals, Torr or mTorr
- hook for easy positioning
- low numeric resolution
- accurate reading

**TO-31895**  
**ROBINAIR**

DIGITAL VACUUM GAUGE

- reads down to 10 microns
- long lead and magnetic strip for  
convenient positioning
- low numeric resolution
- accurate reading



**General Tools and Service Items**

**OIL INJECTORS**

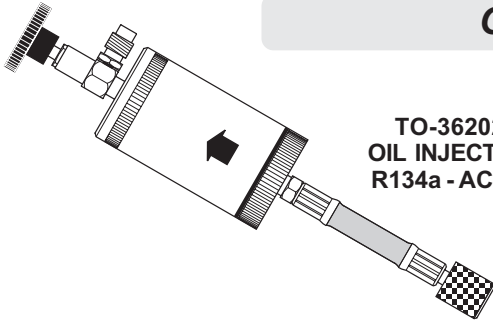

**TO-36202**  
OIL INJECTOR  
R134a - ACME

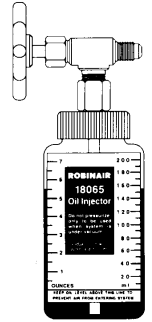

**TO-36234**  
OIL INJECTOR  
R134a - ACME

**GREASE, DEEP VACUUM**



**TO-32250**  
A SPECIAL LOW VAPOUR PRESSURE GREASE FOR USE  
IN VACUUM VALVES, CHARGING MANIFOLDS, ETC.

**MANUAL, SERVICE**

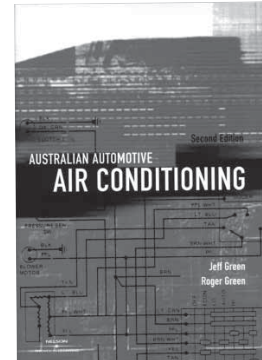

**TO-52642**  
AIR-CHIEF BASIC SERVICE AND TRAINING MANUAL

**MIRROR, INSPECTION**



**TO-54012**  
TELESCOPIC POCKET INSPECTION MIRROR  
EXTENDS TO 200mm.

**SEALANT, LEAK-LOCK**



**TO-70645**  
LEAK-LOCK HOSE FITTING SEALANT.  
IF USED SPARINGLY, THIS SEALANT IS SAFE FOR USE  
ON HOSE FITTINGS IN R-12 SYSTEMS.  
IT IS **NOT** DESIGNED FOR USE WITH SOME LUBRICANTS  
SUCH AS PAG

**SEALANT, O-RING**



**TO-70647**  
HOSE FITTING AND O-RING SEALANT.  
A SAFE SEALANT FOR USE ON O-RINGS AND HOSE  
FITTINGS IN R134a SYSTEMS.

**SEALANT, SYSTEM**

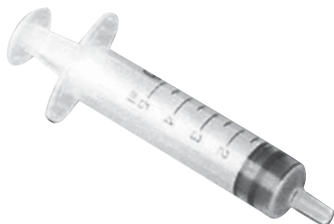

**TO-70655**  
AIRCO-SEAL PRO KIT  
A SAFE SEALANT FOR USE IN R134a SYSTEMS.  
KIT INCLUDES CAN OF SEALANT, TAP AND HOSE

**General Tools and Service Items****SYRINGES**

**TO-73950** UNIVERSAL 10 ml  
**TO-73954** UNIVERSAL 60 ml

THESE SYRINGES ARE USEFUL FOR INJECTING SMALL OR MEASURED AMOUNTS OF SUCH THINGS AS DYE OR LUBRICANT.

**VALVE - QUICK COUPLER**

**TO-79650**

QUICK COUPLER HAND VALVE  
 1/4" MALE FLARE - 1/4" FEM. FLARE

**TOOL, INSPECTION (FIBRE OPTIC)**

**TO-75644** 450mm x 5.8mm dia. probe  
**TO-75647** 450mm x 10.6mm dia. probe

ILLUMINATED FIBRE OPTIC TYPE INSPECTION TOOL

AN INVALUABLE, VERSATILE INSPECTION TOOL FOR AIR CONDITIONING TECHNICIANS, MECHANICS, AND MANY OTHER USES.

**FEATURES:**

- LAMP BUILT INTO THE TIP ILLUMINATES DARK AREAS AT THE TOUCH OF A BUTTON.
- 450mm FLEXIBLE FIBRE OPTIC PROBE (900mm probe model also available)
- INTEGRATED FOCUS ADJUSTMENT
- SEALED LENS AND CABLE ARE SUBMERSIBLE
- SUPPLIED WITH A STURDY, HARD PLASTIC CASE

**OPTIONAL ACCESSORIES FOR 5.8mm PROBE:**

- MAGNET ATTACHMENT (clip-on) **TO-50861**
- MIRROR ATTACHMENT (clip-on) **TO-54124**

**SPARE PARTS:**

REPLACEMENT HALOGEN GLOBE: **TO-31924**  
 (suits 5.8mm and 10.6mm probes)

**TO-50861**  
 CLIP-ON MAGNET  
 (for 5.8mm probe)

**TO-54124**  
 CLIP-ON MIRROR  
 (for 5.8mm probe)

**TO-31924**  
 HALOGEN GLOBE

**TOOL, CRIMPING, MINICRIMP**

**TO-75600**

ATCO MINICRIMP CRIMPING TOOL

FOR USE WITH STANDARD ATCO AFTERMARKET BARB TYPE FITTINGS AND ATCO LONG SERIES MINICRIMP FERRULES.

THIS TOOL IS NOT DESIGNED FOR USE WITH BEADLOCK OR CAPTIVE FERRULE TYPE FITTINGS.

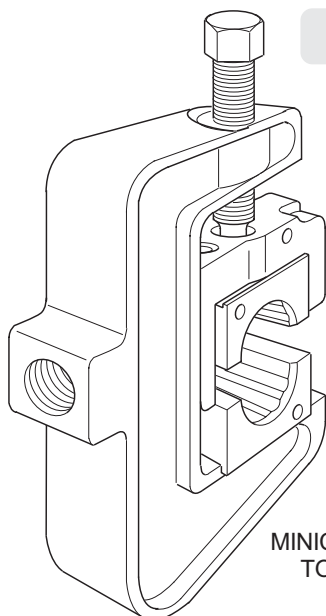

MINICRIMP  
 TOOL

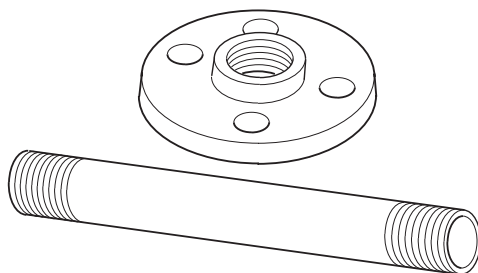

BENCH STAND KIT  
 (INCLUDED)

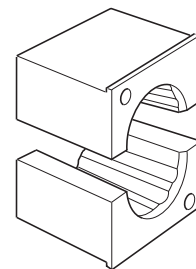
**REPLACEMENT DIES**

|         |        |                 |
|---------|--------|-----------------|
| DIE SET | No. 6  | <b>TO-27306</b> |
| DIE SET | No. 8  | <b>TO-27308</b> |
| DIE SET | No. 10 | <b>TO-27310</b> |
| DIE SET | No. 12 | <b>TO-27312</b> |



## General Tools and Service Items

## TOOLS, CRIMPING, BEADLOCK

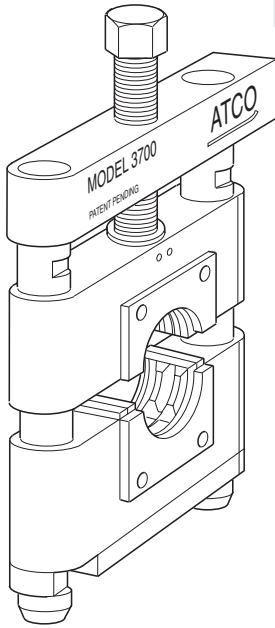

## Standard Beadlock Crimper

## TO-75602

ATCO BEADLOCK CRIMPING TOOL FOR USE WITH BEADLOCK TYPE HOSE FITTINGS.

INCLUDES A COMPLETE SET OF DIES FOR STANDARD DIAMETER HOSE.

## Beadlock Crimper Replacement Parts

|                             |                    |          |          |
|-----------------------------|--------------------|----------|----------|
| CARRIER, SUIT # 6           | DIE (set of 2 pcs) | BLACK    | TO-18306 |
| CARRIER, SUIT # 8           | DIE (set of 2 pcs) | BLUE     | TO-18308 |
| CARRIER, SUIT #10           | DIE (set of 2 pcs) | GREEN    | TO-18310 |
| CARRIER, SUIT #12           | DIE (set of 2 pcs) | YELLOW   | TO-18312 |
| DIE, STANDARD DIAMETER HOSE | No. 6              | TO-27326 |          |
| DIE, STANDARD DIAMETER HOSE | No. 8              | TO-27328 |          |
| DIE, STANDARD DIAMETER HOSE | No. 10             | TO-27330 |          |
| DIE, STANDARD DIAMETER HOSE | No. 12             | TO-27332 |          |
| DIE, REDUCED DIAMETER HOSE  | No. 6              | TO-27346 |          |
| DIE, REDUCED DIAMETER HOSE  | No. 8              | TO-27348 |          |
| DIE, REDUCED DIAMETER HOSE  | No. 10             | TO-27350 |          |
| DIE, REDUCED DIAMETER HOSE  | No. 12             | TO-27352 |          |
| GREASE PLATE, TEFLON LATCH  |                    | TO-32276 |          |
|                             |                    | TO-60560 |          |

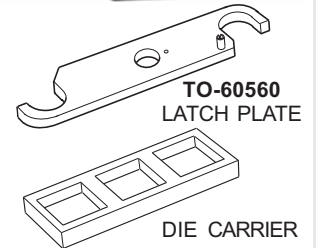

## Manual / Hydraulic Beadlock Crimpers



## TO-75606

HYDRAULIC BEADLOCK CRIMPING TOOL FOR USE WITH BEADLOCK TYPE HOSE FITTINGS.

INCLUDES A COMPLETE SET OF DIES FOR BOTH STANDARD AND REDUCED DIAMETER BARRIER HOSE.

## Replacement Parts

|                                  |                             |          |
|----------------------------------|-----------------------------|----------|
| DIE SET, Black                   | # 6 reduced hose            | TO-27115 |
| DIE SET, Purple                  | # 6 std. & # 8 reduced hose | TO-27116 |
| DIE SET, Red                     | # 8 standard hose           | TO-27118 |
| DIE SET, Orange                  | # 10 reduced hose           | TO-27119 |
| DIE SET, Yellow                  | # 10 standard hose          | TO-27120 |
| DIE SET, Blue                    | # 12 reduced hose           | TO-27121 |
| DIE SET, Green                   | # 12 standard hose          | TO-27122 |
| HEAD, Crimper                    |                             | TO-34047 |
| PIN, Yoke pin and Chain assembly |                             | TO-60425 |
| RAM, Hydraulic arm               |                             | TO-66185 |



## TO-75609

MANUAL / HYDRAULIC BEADLOCK CRIMPING TOOL FOR USE WITH BEADLOCK TYPE HOSE FITTINGS.

INCLUDES A COMPLETE SET OF DIES TO SUIT BOTH STANDARD AND REDUCED DIAMETER BARRIER HOSE.

## FEATURES INCLUDE:

- COMPACT, MODULAR TOOL
- LIGHTWEIGHT ALLOY BODY
- CAN BE HAND - HELD OR BENCH MOUNTED
- CONVERTS TO HYDRAULIC OPERATION EASILY
- REPLACEMENT OF DIES IS QUICK AND SIMPLE
- NO SPECIAL TOOLS REQUIRED

## Replacement Parts

|                 |                              |          |
|-----------------|------------------------------|----------|
| CARRIER, White  | # 6 reduced hose             | TO-18265 |
| CARRIER, Yellow | # 6 std. & # 8 reduced hose  | TO-18266 |
| CARRIER, Red    | # 8 standard hose.           | TO-18268 |
| CARRIER, Black  | # 10 reduced hose.           | TO-18269 |
| CARRIER, Green  | # 10 std. & #12 reduced hose | TO-18270 |
| CARRIER, Blue   | # 12 standard hose.          | TO-18272 |

- • NOTE: carriers are supplied as a set (2 pcs)

|                    |                              |          |
|--------------------|------------------------------|----------|
| DIE SET, White     | # 6 reduced hose             | TO-27225 |
| DIE SET, Yellow    | # 6 std. & # 8 reduced hose  | TO-27226 |
| DIE SET, Red       | # 8 standard hose.           | TO-27228 |
| DIE SET, Black     | # 10 reduced hose.           | TO-27229 |
| DIE SET, Green     | # 10 std. & #12 reduced hose | TO-27230 |
| DIE SET, Blue      | # 12 standard hose.          | TO-27232 |
| RAM, Hydraulic arm |                              | TO-66197 |

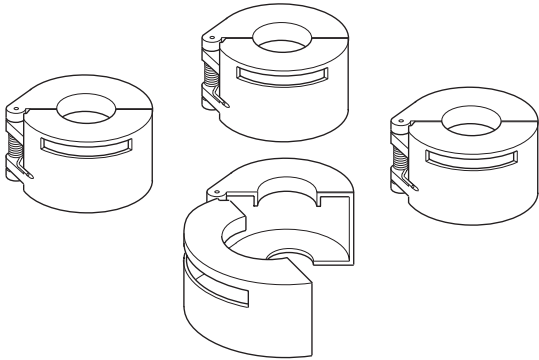
**General Tools and Service Items****TOOL, SPRINGLOCK****TO-75625**

SPRINGLOCK HOSE FITTING REPAIR TOOL. KIT  
COMPRISES SET OF No.6, 8, 10, AND 12

**TOOL, ORIFICE REMOVER****TO-75672**

ORIFICE TUBE REMOVER.  
COMBINATION TOOL, SUITS FORD AND GM ORIFICE TUBES

**TOOL, TUBE BENDER****TO-75715**

HAND HELD TUBE BENDER  
FOR USE WITH COPPER AND ALLOY TUBING  
SUITS: 3/16", 1/4", 5/16" AND 3/8" TUBING

**TOOL, VALVE CORE****TO-75875**

CORE REMOVER FOR STANDARD  
AIR CONDITIONING ACCESS  
VALVE CORES.

**TO-75881**

CORE REMOVING TOOL FOR HIGH-FLOW  
AIR CONDITIONING ACCESS VALVE CORES.  
SUITS MOST STANDARD AND HIGH-FLOW CORES

**WRENCHES****TO-81340**

4-WAY RATCHET WRENCH  
3/16" - 1/4" AND 1/2" - 9/16"

**TO-81360**

4-WAY RATCHET WRENCH  
3/16" - 1/4" AND 5/16" - 3/8"



**Unions**

**CYLINDER, MANIFOLD & VACUUM PUMP**

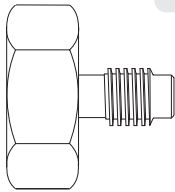

**REFRIGERANT CYLINDER UNION**  
 3/4" FEM. GAS- 1/4" MF **TO-77300**  
 3/4" FEM. GAS- 1/2" ACME **TO-77334**

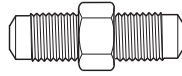

**TO-77400**  
 CHARGING LINE UNION  
 1/4"MF - 1/4"MF

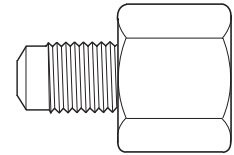

**TO-77432**  
 MANIFOLD UNION  
 1/2" FEM ACME - 10mm MALE METRIC

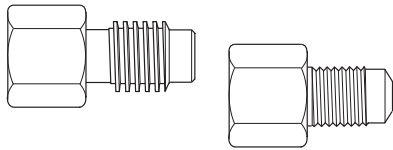

**VACUUM PUMP UNIONS**  
 1/4" FEM. FLARE-1/2" MALE ACME **TO-77450**  
 1/2" FEM. ACME -1/4" MALE FLARE **TO-77475**

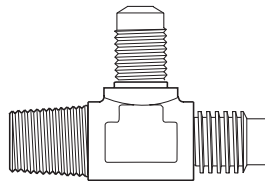

**TO-77500**  
 VACUUM PUMP 'T' UNION  
 MALE PIPE - 1/2" MALE ACME - 1/4" MF

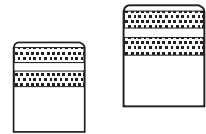

**CYLINDER UNION DUST CAPS**  
 CAP FOR 1/4" MF **CO-80795**  
 CAP FOR 1/2" ACME **TO-18234**

**Specialized Service Tools**

**COMPRESSOR SERVICE TOOLS**



**TO-90175**  
 DIPSTICK  
 SANDEN SD5 SERIES

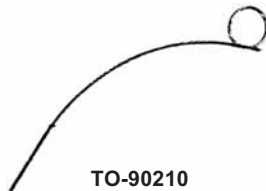

**TO-90210**  
 DIPSTICK  
 YORK AND TECUMSEH



**TO-91180**  
 UNIVERSAL CLUTCH  
 HOLDING TOOL



**TO-91212**  
 DELPHI V5 CLUTCH  
 HOLDING TOOL



**TO-91240**  
 SANDEN CLUTCH  
 HOLDING TOOL



**TO-92015**  
 O-RING INSTALLER  
 DELCO A6  
 (REPLACES TO-92010)

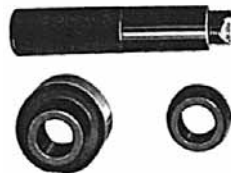

**TO-92050**  
 DELCO A6 PULLEY  
 INSTALLER



**TO-92900**  
 DELCO A6  
 SEAL PROTECTOR



**TO-92934**  
 SEAL SLEEVE  
 PROTECTOR  
 SANDEN SD505 & 507



**TO-92940**  
 SANDEN SD508 SEAL  
 PROTECTOR



**TO-92970**  
 SEAL SLEEVE  
 PROTECTOR  
 SANDEN TR & C SERIES



**TO-93010**  
 CLUTCH PLATE PULLER  
 SANDEN SD505 & 507



**TO-93040**  
 UNIVERSAL PULLEY  
 PULLER



**TO-93100**  
 ROTOR & BEARING  
 PULLER  
 SANDEN SD505 & 507



**TO-93690**  
 NIPPON DENSO  
 HUB REMOVER

**Specialized Service Tools****COMPRESSOR SERVICE TOOLS**

**TO-93800**  
UNIVERSAL O-RING  
REMOVER



**TO-93892**  
DELCO A6 HUB REMOVER  
(use with TO-93895 INSTALLER)



**TO-93895**  
DELCO A6 HUB INSTALLER  
(USE WITH TO-93892  
HUB REMOVER)



**TO-93897**  
DELPHI V5 HUB REMOVER  
(USE WITH TO-93898  
HUB REMOVER)



**TO-93898**  
DELPHI V5 HUB INSTALLER  
(USE WITH TO-93897  
HUB REMOVER)



**TO-94020**  
SEAL REMOVER-INSTALLER  
DELCO CERAMIC SEAL



**TO-94035**  
SEAL REMOVER-INSTALLER  
DELCO STEEL SEAL



**TO-94041**  
DELCO A6 AND R4  
SEAL REMOVER - INSTALLER  
(COMPLETE KIT)



**TO-94060**  
SEAL SEAT  
REMOVER-INSTALLER  
DELCO A6; SANDEN SD508  
(ALSO EARLY SD507)



**TO-94257**  
SEAL REMOVER-INSTALLER  
SANDEN SD505; LATE SD507  
AND TR SERIES



**TO-94270**  
SEAL REMOVER-INSTALLER  
SANDEN EARLY SD507; SD508



**TO-94295**  
SEAL SEAT  
REMOVER-INSTALLER  
SANDEN SD505; LATE SD507



**TO-94320**  
SEAL REMOVER-INSTALLER  
SANDEN SD7H



**TO-94375**  
SEAL REMOVER-INSTALLER  
SANDEN TRS